

**IPU 40188 People Counter Mounting Height Graph Issue 8**

Valid for all units in the Gazelle series People Counters.



**90 Degree Units / Metric**



90° Field Of View						
Mounting Height Range (m)	Typical Detection Region (m)	Separation for Wide Opening (m)		Optimum Distance Away From Door (m)		
		Min	Max	Min	Max	
Absolute Minimum	2.50	3.18	2.36	2.95	1.00	1.59
<b>Recommended Range</b>	<b>2.50</b> <b>4.50</b>	<b>3.18</b> <b>6.13</b>	2.36 4.71	2.95 5.89	1.00	1.59 3.07
Absolute Maximum	4.50	6.13	4.71	5.89	1.00	3.07

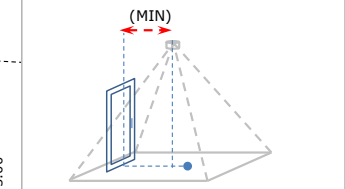
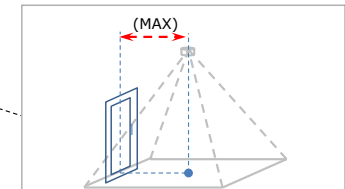
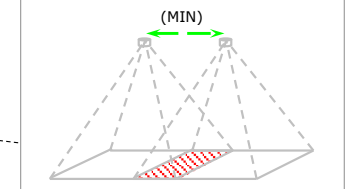
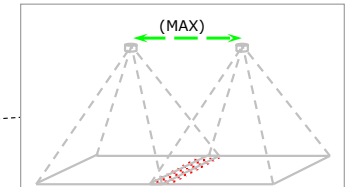
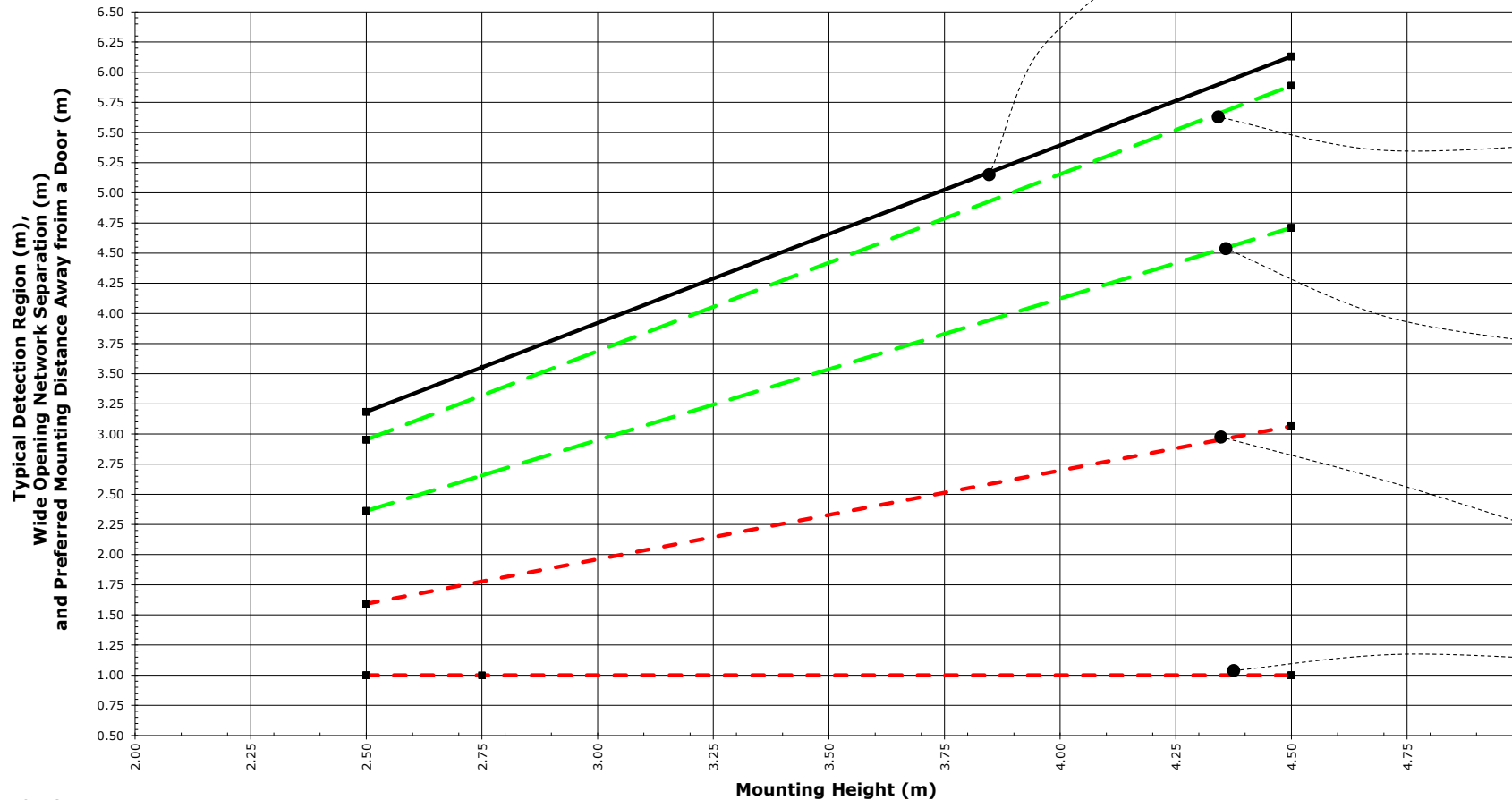
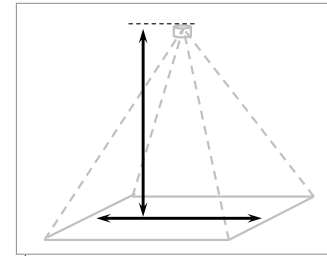

**NOTES:**

1. Always use the correct lens variant for the mounting height. Between 2.5m and 4.5m high, either the 90 degree or 60 degree lens variants can be used, with the 90 degree unit providing more coverage at the same height.
2. The solid black line indicates the Typical Detection Region which is maximum reliable coverage for a single counter mounted at the given height. This will be reduced in the direction of motion due to normal initialisation constraints (See Applications Notes document IPU40184).
3. The green dashed lines indicates the preferred Minimum and Maximum Separations in 'Wide Opening Network' counter configurations. Counters should ideally be positioned at a distance between these two values, but in any case never further apart than the maximum.
4. The red dashed lines indicate the preferred Minimum and Maximum mounting distances from a door. Ideally the counter should be mounted between the max and min positions, but in any case should be mounted outside the arc of a swinging door.

**IPU 40188 People Counter Mounting Height Graph Issue 8**

Valid for all units in the Gazelle (and IRC3000) series People Counters.



**60 Degree Units / Metric**



60° Field Of View						
Mounting Height Range (m)	Typical Detection Region (m)	Separation for Wide Opening (m)		Optimum Distance Away From Door (m)		
		Min	Max	Min	Max	
Absolute Minimum	2.20	1.97	1.43	1.78	1.00	1.00
<b>Recommended Range</b>	<b>2.50</b> <b>4.50</b>	<b>2.27</b> <b>4.23</b>	1.66 3.23	2.08 4.04	1.00 1.69	1.13 2.11
Absolute Maximum	4.80	4.52	3.46	4.33	1.81	2.26

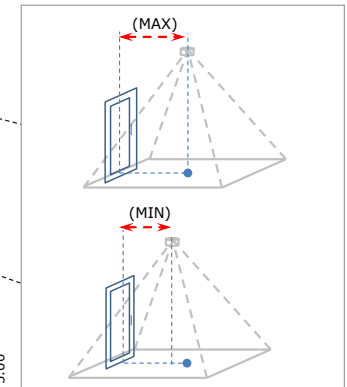
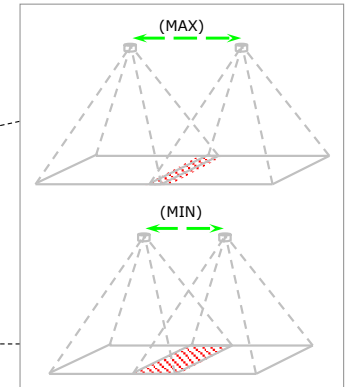
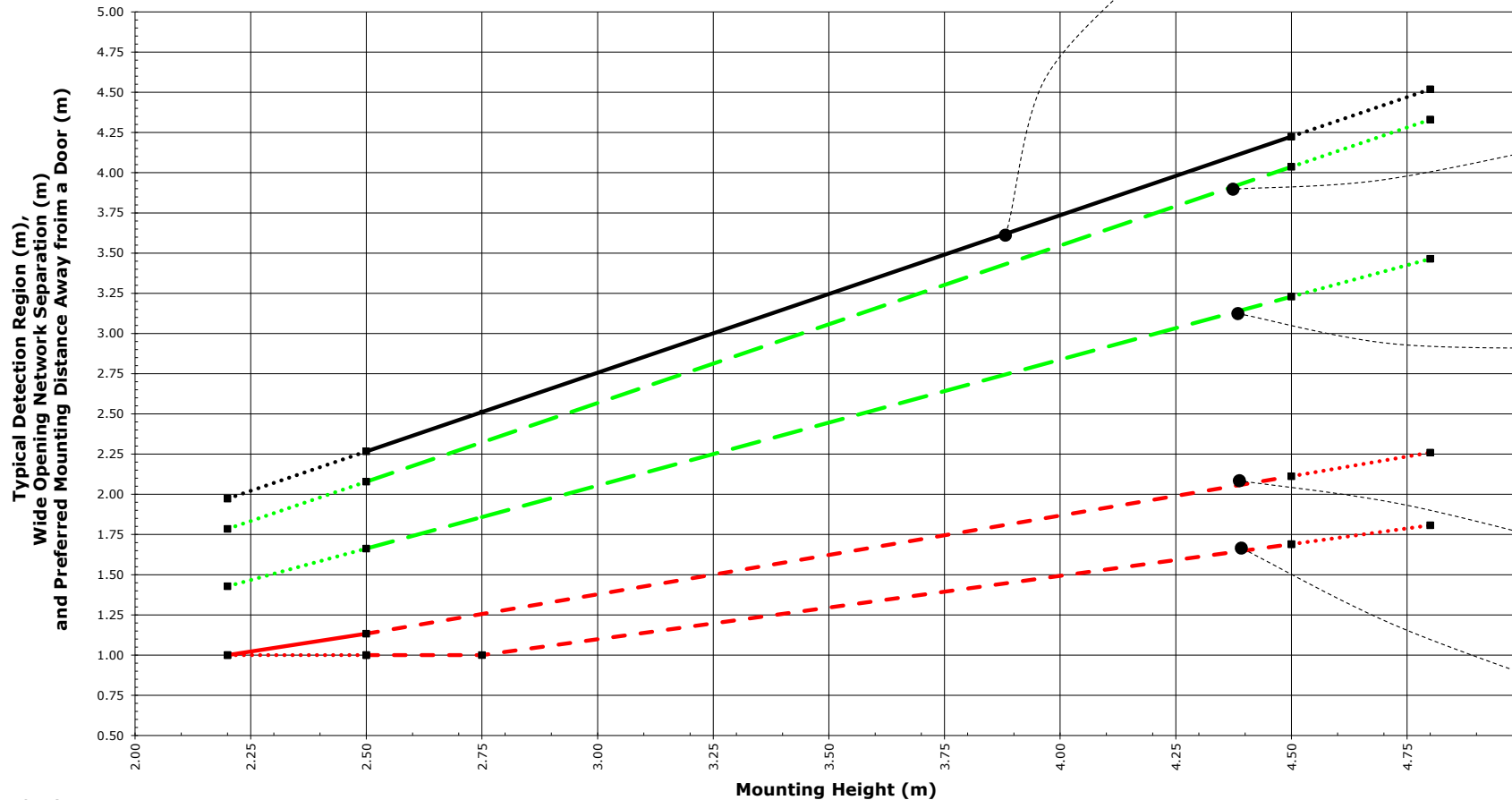
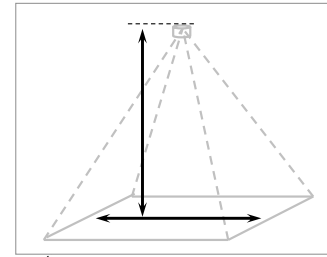

**NOTES:**

1. Always use the correct lens variant for the mounting height. Between 4m and 4.5m high, either the 60 degree or 40 degree lens variants can be used, with the 60 degree unit providing more coverage at the same height.
2. The solid black line indicates the Typical Detection Region which is maximum reliable coverage for a single counter mounted at the given height. This will be reduced in the direction of motion due to normal initialisation constraints (See Applications Notes document IPU40184).
3. The green dashed lines indicates the preferred Minimum and Maximum Separations in 'Wide Opening Network' counter configurations. Counters should ideally be positioned at a distance between these two values, but in any case never further apart than the maximum.
4. The red dashed lines indicate the preferred Minimum and Maximum mounting distances from a door. Ideally the counter should be mounted between the max and min positions, but in any case should be mounted outside the arc of a swinging door.
5. Between 2.2m and 2.5m, and between 4.5m and 4.8m, counting accuracy may be reduced slightly for 60 degree units.

**IPU 40188 People Counter Mounting Height Graph Issue 8**

Valid for all units in the Gazelle (and 3000) series People Counters.



**40 Degree Units / Metric**



40° Field Of View						
Mounting Height Range (m)	Typical Detection Region (m)	Separation for Wide Opening (m)		Optimum Distance Away From Door (m)		
		Min	Max	Min	Max	
Absolute Minimum	3.50	2.00	1.48	1.85	1.00	1.00
<b>Recommended Range</b>	<b>4.00</b>	<b>2.31</b>	1.73	2.16	1.00	1.16
	<b>7.00</b>	<b>4.16</b>	3.22	4.03	1.67	2.08
Absolute Maximum	7.50	4.47	3.47	4.34	1.79	2.24

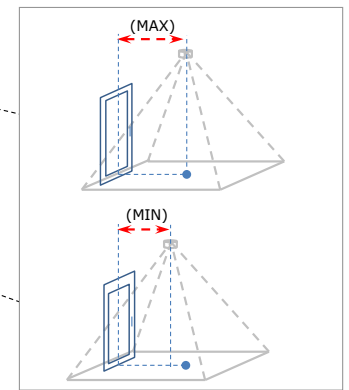
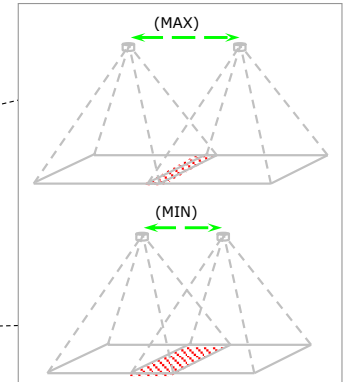
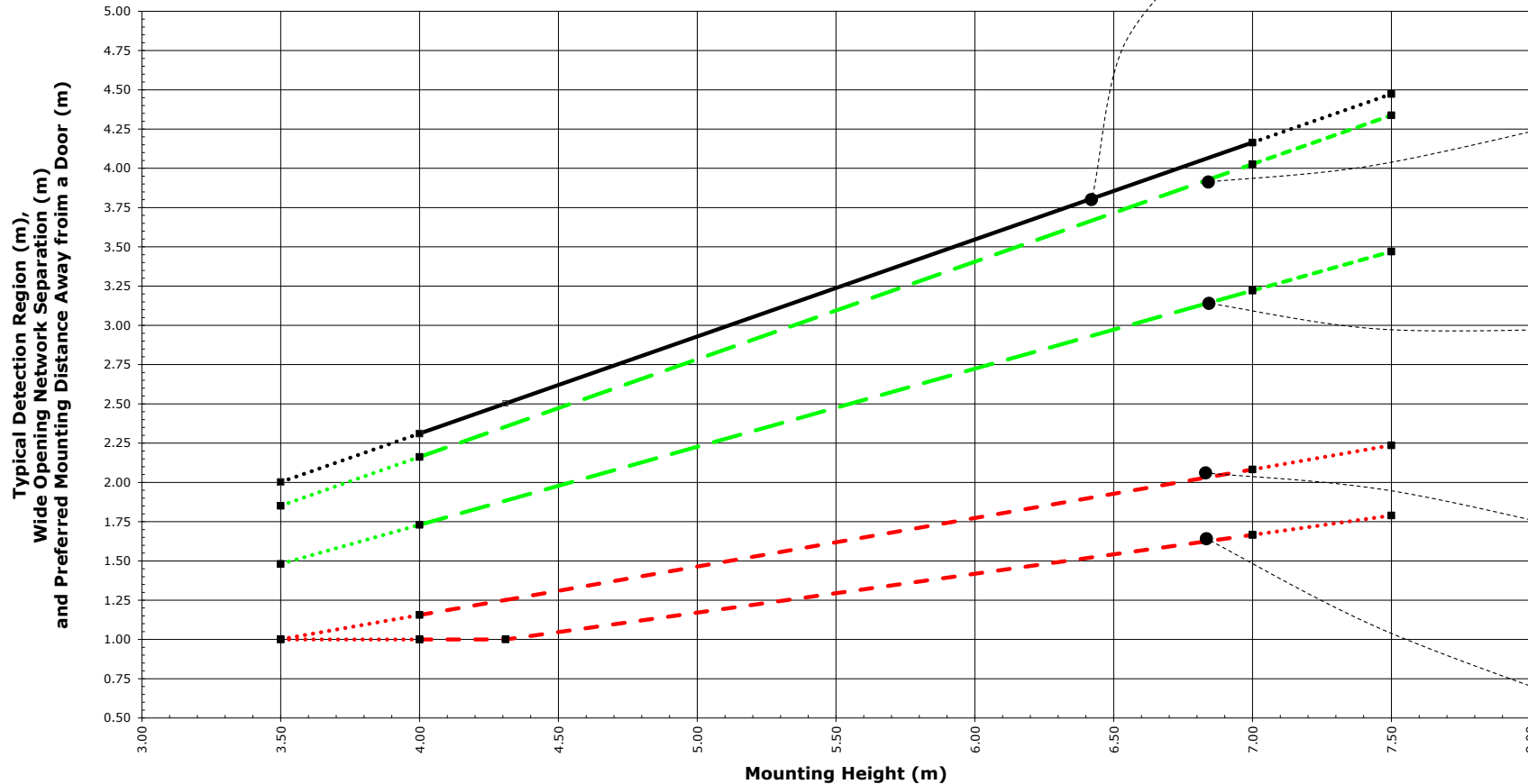
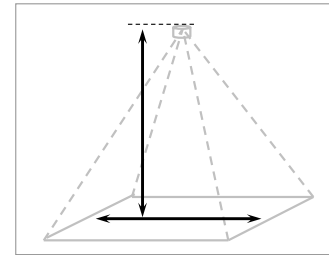

- NOTES:
1. Always use the correct lens variant for the mounting height. Between 4m and 4.5m high, either the 60 degree or 40 degree lens variants can be used, with the 60 degree unit providing more coverage at the same height.
  2. The solid black line indicates the Typical Detection Region which is maximum reliable coverage for a single counter mounted at the given height. This will be reduced in the direction of motion due to normal initialisation constraints (See Applications Notes document IPU40184).
  3. The green dashed lines indicates the preferred Minimum and Maximum Separations in 'Wide Opening Network' counter configurations. Counters should ideally be positioned at a distance between these two values, but in any case never further apart than the maximum.
  4. The red dashed lines indicate the preferred Minimum and Maximum mounting distances from a door. Ideally the counter should be mounted between the max and min positions, but in any case should be mounted outside the arc of a swinging door.
  5. Between 3.5m and 4.0m, and between 7.0m and 7.5m, counting accuracy may be reduced slightly for 40 degree units.

**IPU 40188 People Counter Mounting Height Graph Issue 8**  
Valid for all units in the 3000 series (outdoor only) People Counters.



**20 Degree Units / Metric**



20° Field Of View						
Mounting Height Range (m)	Typical Detection Region (m)	Separation for Wide Opening (m)		Optimum Distance Away From Door (m)		
		Min	Max	Min	Max	
Absolute Minimum	7.00	2.01	1.51	1.89	1.00	1.00
<b>Recommended Range</b>	<b>8.00</b> <b>14.50</b>	<b>2.29</b> <b>4.15</b>	1.74 3.24	2.17 4.05	1.00 1.66	1.15 2.07
Absolute Maximum	15.50	4.43	3.47	4.34	1.77	2.22

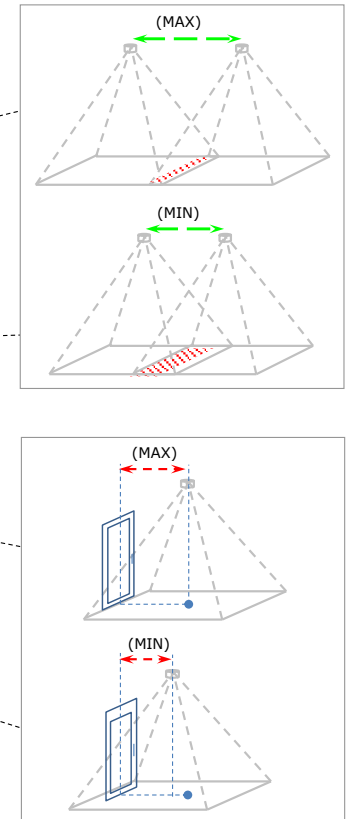
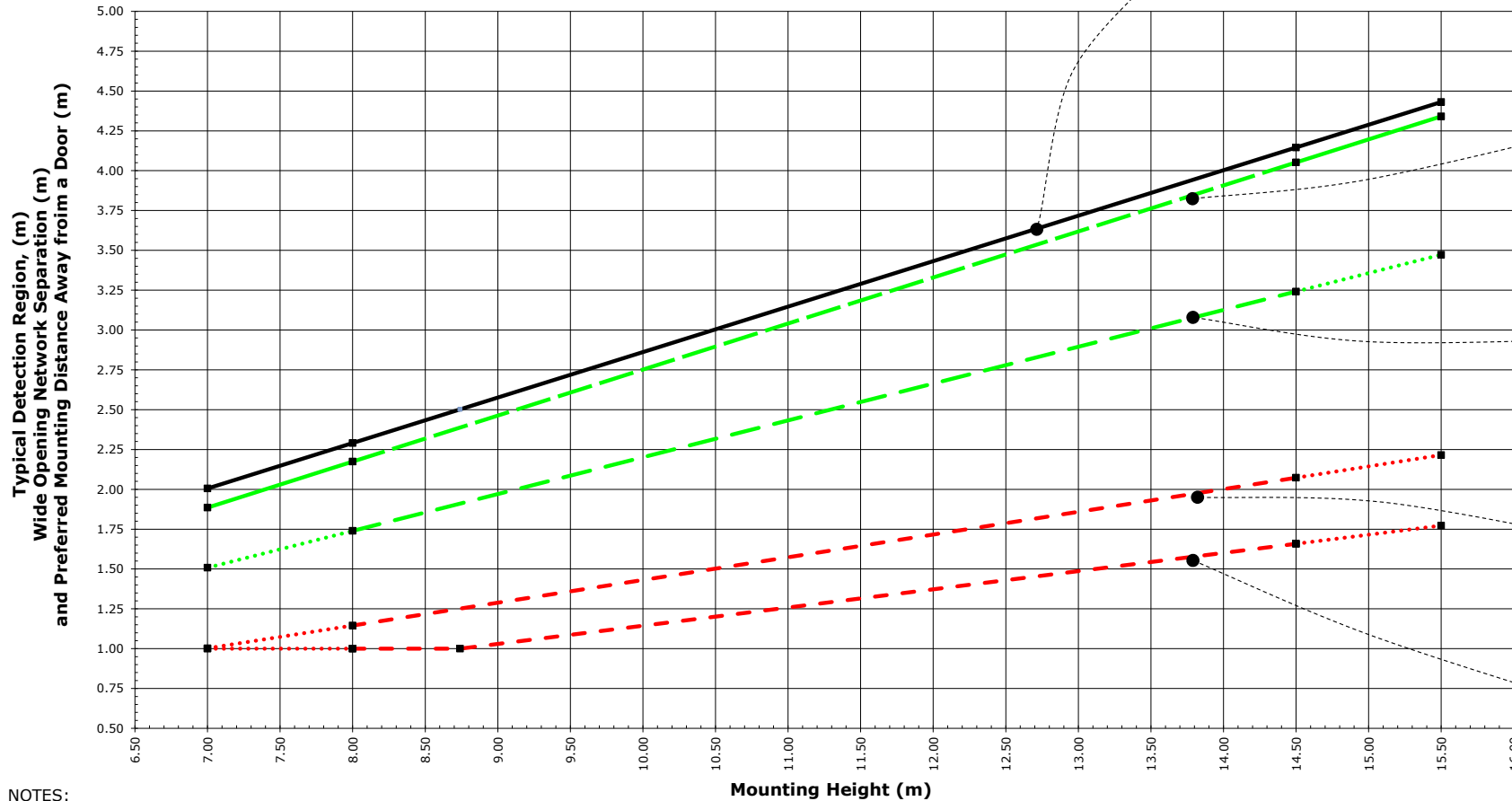
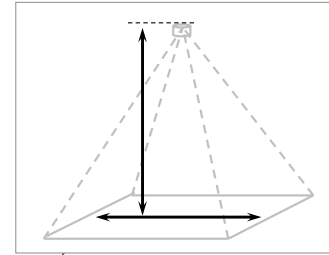

- NOTES:
1. Always use the correct lens variant for the mounting height.
  2. The solid black line indicates the Typical Detection Region which is maximum reliable coverage for a single counter mounted at the given height. This will be reduced in the direction of motion due to normal initialisation constraints (See Applications Notes document IPU40184).
  3. The green dashed lines indicates the preferred Minimum and Maximum Separations in 'Wide Opening Network' counter configurations. Counters should ideally be positioned at a distance between these two values, but in any case never further apart than the maximum.
  4. The red dashed lines indicate the preferred Minimum and Maximum mounting distances from a door. Ideally the counter should be mounted between the max and min positions, but in any case should be mounted outside the arc of a swinging door.
  5. Between 7.0m and 8.0m, and between 14.5m and 15.5m, counting accuracy may be reduced slightly for 20 degree units.

**IPU 40188 People Counter Mounting Height Graph Issue 8**

Valid for all units in the Gazelle 2, Gazelle and 3000 series People Counters.

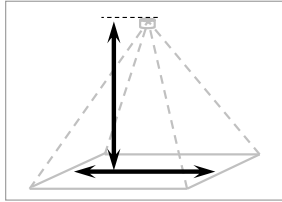

**90, 60, 40, & 20 Degree Units / Metric**

90° Field Of View		
Mounting Height Range (m)		Typical Detection Region (m)
Absolute Minimum	2.50	3.18
<b>Recommended Range</b>	<b>2.50</b> <b>4.50</b>	<b>3.18</b> <b>6.13</b>
Absolute Maximum	4.50	6.13

60° Field Of View		
Mounting Height Range (m)		Typical Detection Region (m)
Absolute Minimum	2.20	1.97
<b>Recommended Range</b>	<b>2.50</b> <b>4.50</b>	<b>2.27</b> <b>4.23</b>
Absolute Maximum	4.80	4.52

40° Field Of View		
Mounting Height Range (m)		Typical Detection Region (m)
Absolute Minimum	3.50	2.00
<b>Recommended Range</b>	<b>4.00</b> <b>7.00</b>	<b>2.31</b> <b>4.16</b>
Absolute Maximum	7.50	4.47

20° Field Of View		
Mounting Height Range (m)		Typical Detection Region (m)
Absolute Minimum	7.00	2.01
<b>Recommended Range</b>	<b>8.00</b> <b>14.50</b>	<b>2.29</b> <b>4.15</b>
Absolute Maximum	15.50	4.43

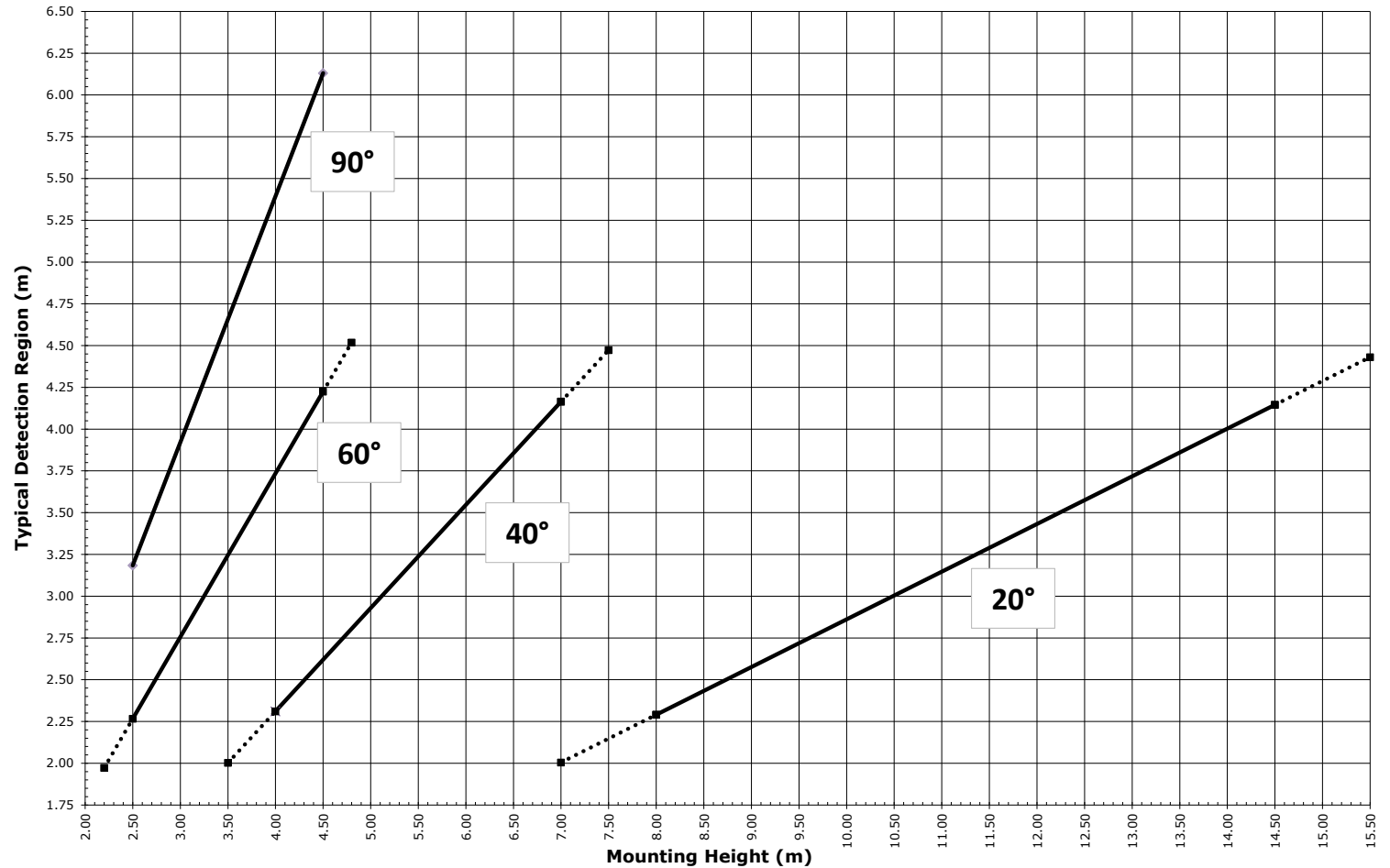

**NOTES:**

1. Always use the correct lens variant for the mounting height.
2. The solid black line indicates the Typical Detection Region which is maximum reliable coverage for a single counter mounted at the given height. This will be reduced in the direction of motion due to normal initialisation constraints (See Applications Notes document IPU40184).
3. The solid line endpoints indicate the recommended (preferred) mounting height range. Always install within this height range whenever possible.
4. The dashed line ends indicate the extended allowable height range. Changes bto the counters discrimination sensitivity slider setting will be required at these heights.
5. Between 2.2m and 2.5m, and between 4.5m and 4.8m, counting accuracy may be reduced slightly for 60 degree units.
6. Between 3.5m and 4.0m, and between 7.0m and 7.5m, counting accuracy may be reduced slightly for 40 degree units.
7. Between 7.0m and 8.0m, and between 14.5m and 15.5m, counting accuracy may be reduced slightly for 20 degree units.

# IPU 40188 People Counter Mounting Height Graph Issue 8

Valid for all units in the Gazelle series People Counters.



**90 Degree Units / Imperial**

90° Field Of View						
Mounting Height Range (inches)	Typical Detection Region (inches)	Separation for Wide Opening (inches)		Optimum Distance Away From Door (inches)		
		Min	Max	Min	Max	
Absolute Minimum	98 3/7	125 1/3	93	116 1/4	39 3/8	62 2/3
<b>Recommended Range</b>	<b>98 3/7</b> <b>177 1/6</b>	<b>125 1/3</b> <b>241 3/8</b>	93 185 4/9	116 1/4 231 4/5	39 3/8 39 3/8	62 2/3 120 2/3
Absolute Maximum	177 1/6	241 3/8	185 4/9	231 4/5	39 3/8	120 2/3

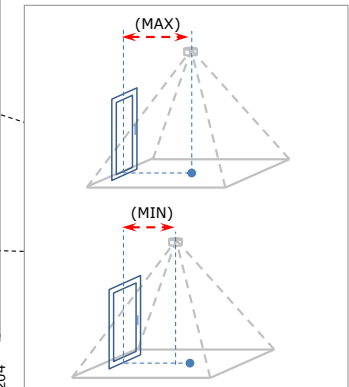
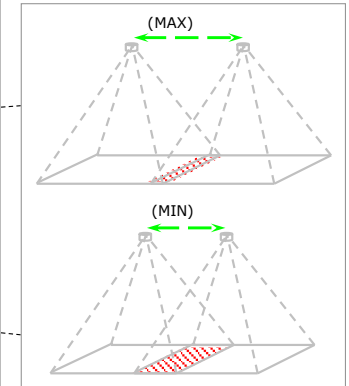
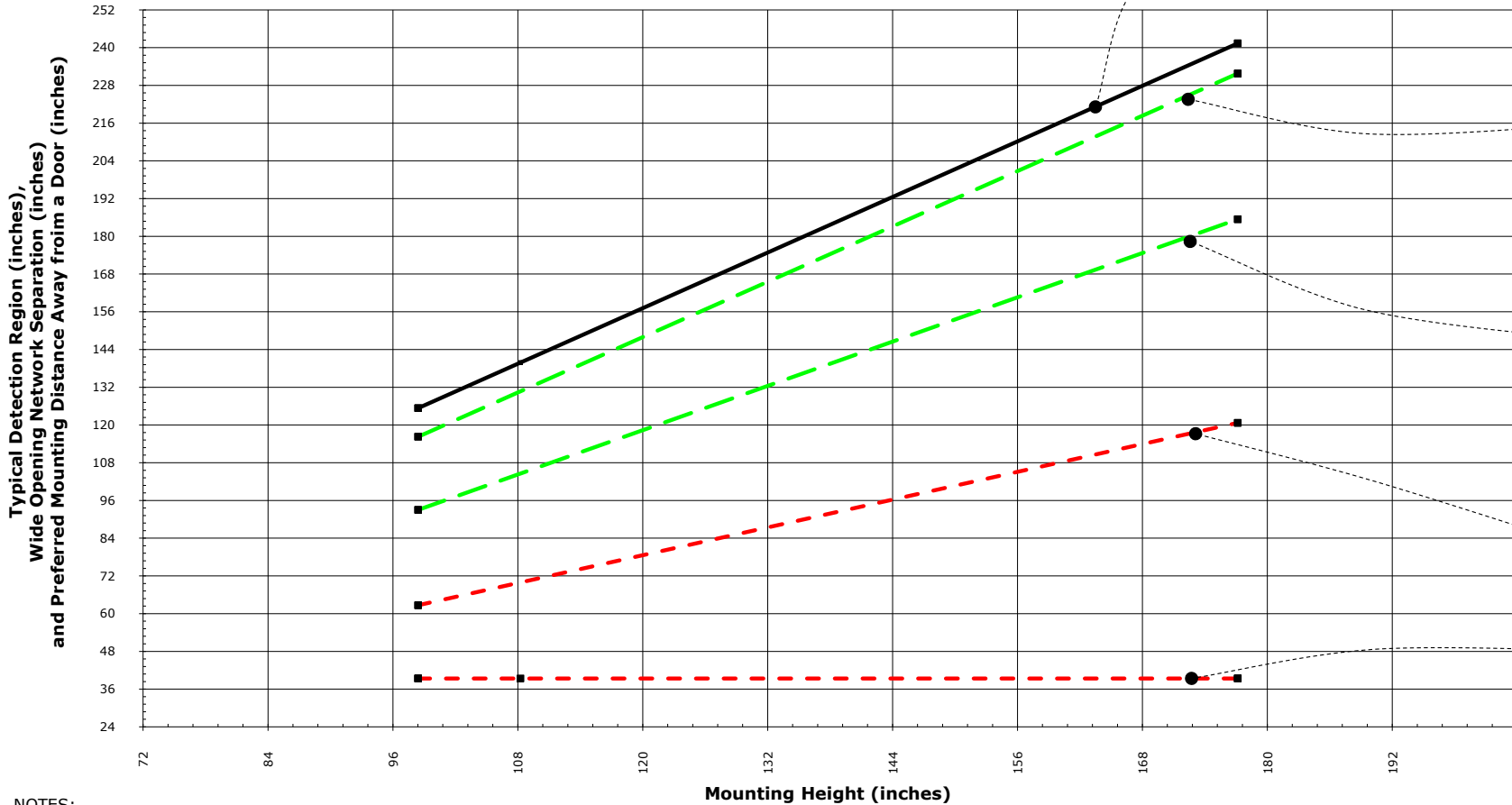
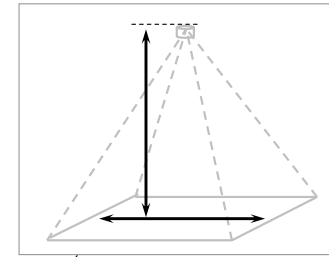

## NOTES:

1. Always use the correct lens variant for the mounting height. Between 98" and 177" high, either the 90 degree or 60 degree lens variants can be used, with the 90 degree unit providing more coverage at the same height.
2. The solid black line indicates the Typical Detection Region which is maximum reliable coverage for a single counter mounted at the given height. This will be reduced in the direction of motion due to normal initialisation constraints (See Applications Notes document IPU40184).
3. The green dashed lines indicates the preferred Minimum and Maximum Separations in 'Wide Opening Network' counter configurations. Counters should ideally be positioned at a distance between these two values, but in any case never further apart than the maximum.
4. The red dashed lines indicate the preferred Minimum and Maximum mounting distances from a door. Ideally the counter should be mounted between the max and min positions, but in any case should be mounted outside the arc of a swinging door.

### IPU 40188 People Counter Mounting Height Graph Issue 8

Valid for all units in the Gazelle (and IRC3000) series People Counters.



60 Degree Units / Imperial



60° Field Of View						
Mounting Height Range (inches)	Typical Detection Region (inches)	Separation for Wide Opening (inches)		Optimum Distance Away From Door (inches)		
		Min	Max	Min	Max	
Absolute Minimum	86 3/5	77 2/3	56 1/5	70 1/4	39 3/8	39 3/8
<b>Recommended Range</b>	<b>98 3/7</b> <b>177 1/6</b>	<b>89 1/4</b> <b>166 1/3</b>	<b>65 1/2</b> <b>127 1/7</b>	<b>81 5/6</b> <b>159</b>	<b>39 3/8</b> <b>66 1/2</b>	<b>44 5/8</b> <b>83 1/6</b>
Absolute Maximum	189	178	136 2/5	170 1/2	71 1/6	89

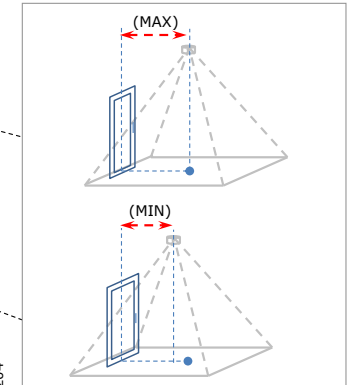
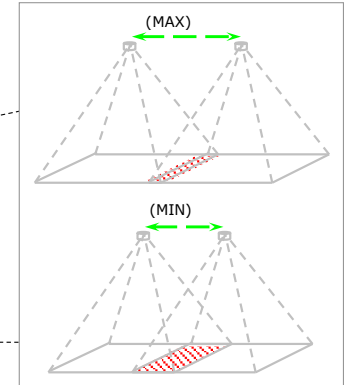
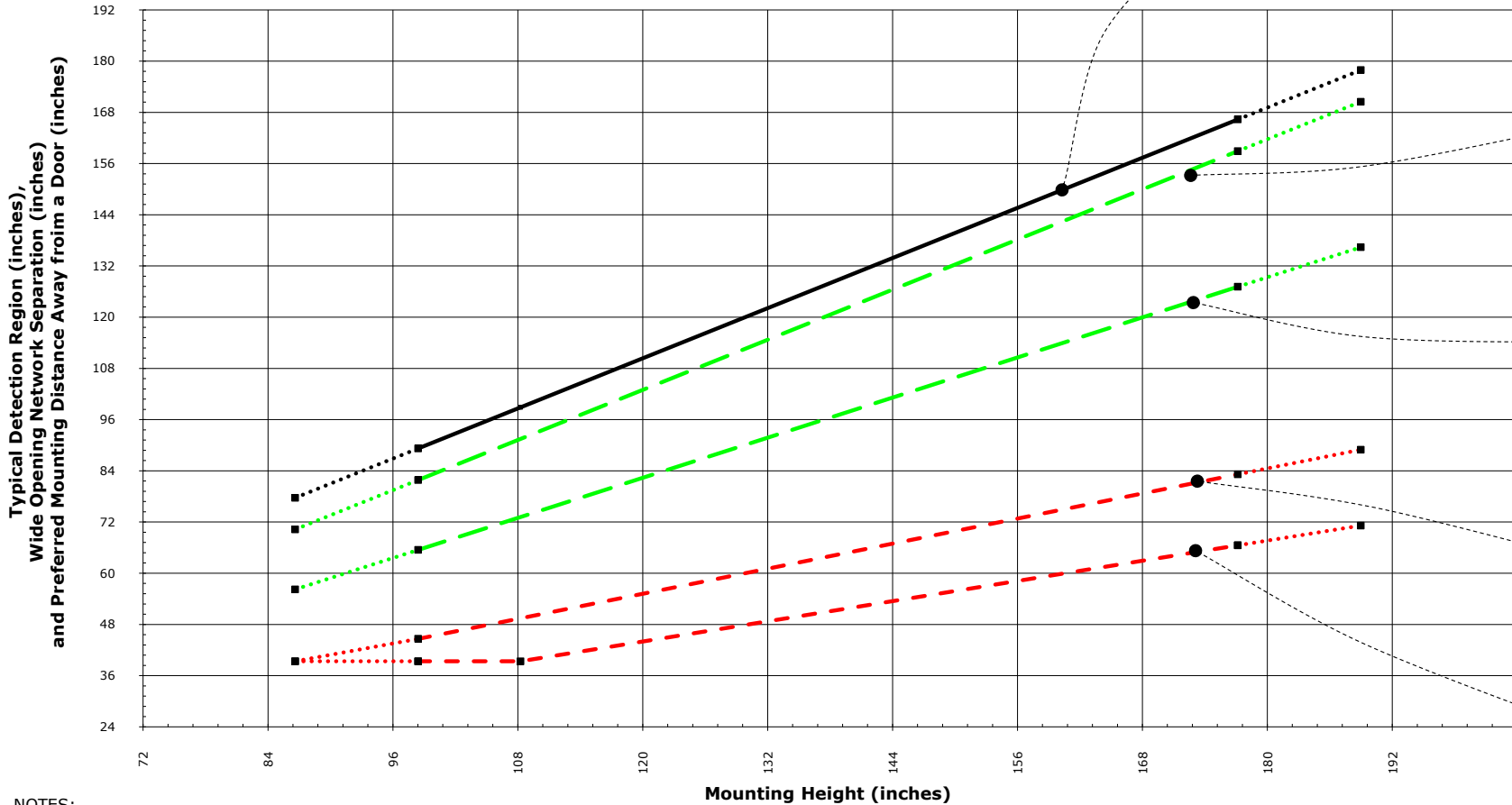
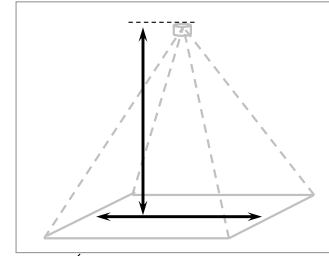

**NOTES:**

1. Always use the correct lens variant for the mounting height. Between 157" and 177" high, either the 60 degree or 40 degree lens variants can be used, with the 60 degree unit providing more coverage at the same height.
2. The solid black line indicates the Typical Detection Region which is maximum reliable coverage for a single counter mounted at the given height. This will be reduced in the direction of motion due to normal initialisation constraints (See Applications Notes document IPU40184).
3. The green dashed lines indicates the preferred Minimum and Maximum Separations in 'Wide Opening Network' counter configurations. Counters should ideally be positioned at a distance between these two values, but in any case never further apart than the maximum.
4. The red dashed lines indicate the preferred Minimum and Maximum mounting distances from a door. Ideally the counter should be mounted between the max and min positions, but in any case should be mounted outside the arc of a swinging door.
5. Between 87" and 99", and between 177" and 189", counting accuracy may be reduced slightly for 60 degree units.

**IPU 40188 People Counter Mounting Height Graph Issue 8**

Valid for all units in the Gazelle (and 3000) series People Counters.



**40 Degree Units / Imperial**



40° Field Of View						
Mounting Height Range (inches)	Typical Detection Region (inches)	Separation for Wide Opening (inches)		Optimum Distance Away From Door (inches)		
		Min	Max	Min	Max	
Absolute Minimum	137 4/5	78 5/6	58 1/3	72 8/9	39 3/8	39 3/7
<b>Recommended Range</b>	<b>157 1/2</b>	<b>91</b>	<b>68 1/9</b>	<b>85 1/8</b>	<b>39 3/8</b>	<b>45 1/2</b>
	<b>275 3/5</b>	<b>164</b>	<b>126 5/6</b>	<b>158 1/2</b>	<b>65 4/7</b>	<b>82</b>
Absolute Maximum	295 2/7	176 1/8	136 5/8	170 7/9	70 4/9	88

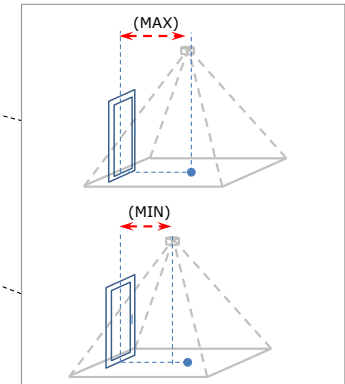
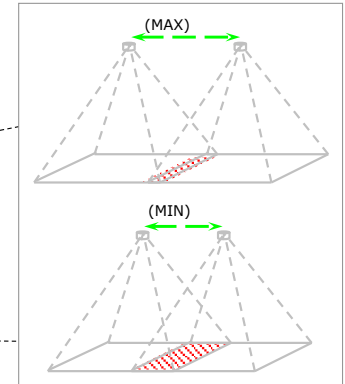
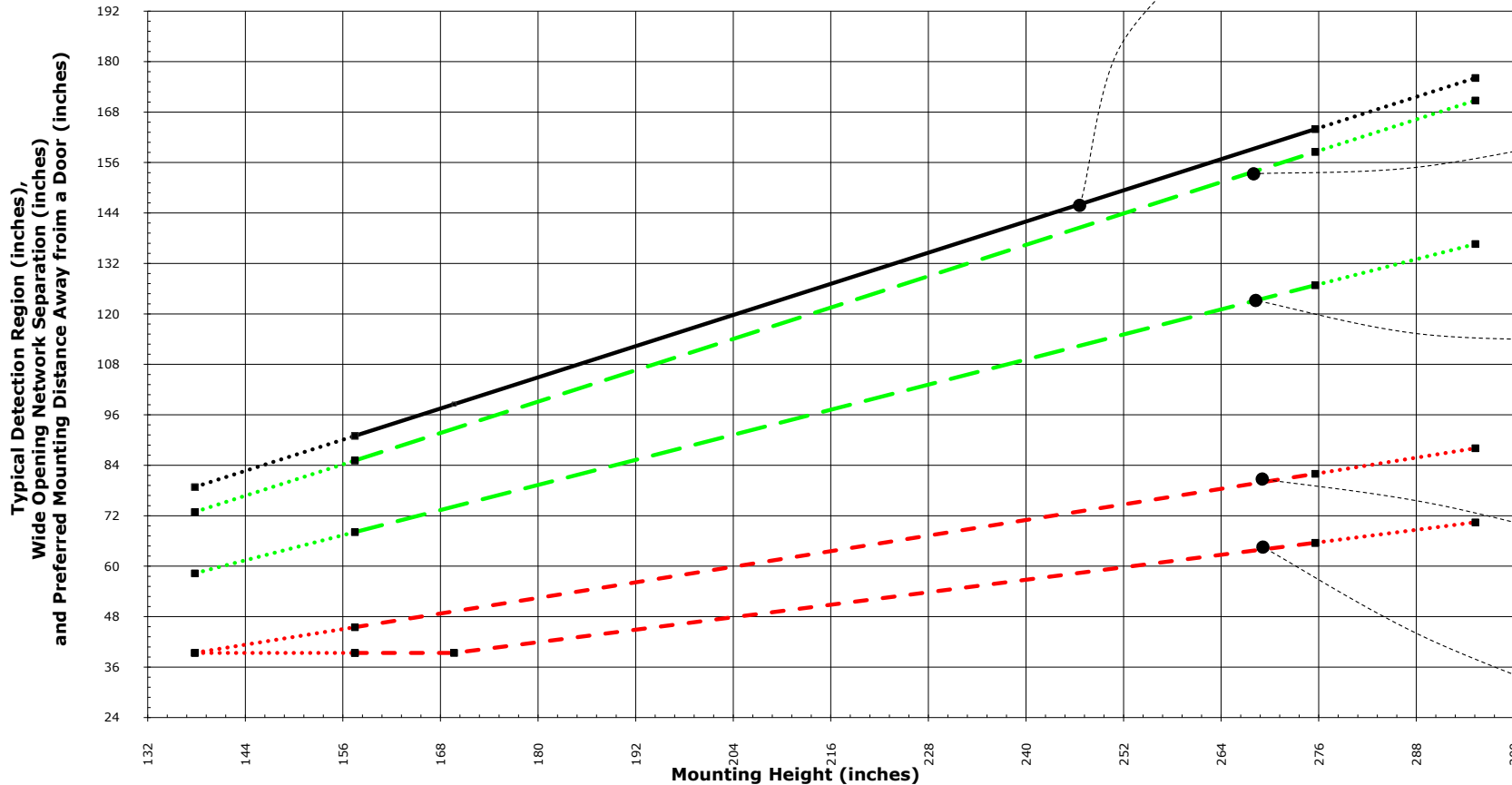
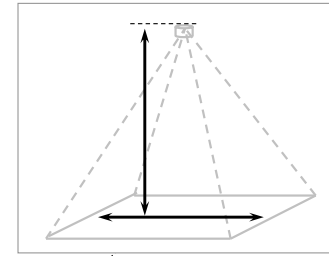

**NOTES:**

1. Always use the correct lens variant for the mounting height. Between 157" and 177" high, either the 60 degree or 40 degree lens variants can be used, with the 60 degree unit providing more coverage at the same height.
2. The solid black line indicates the Typical Detection Region which is maximum reliable coverage for a single counter mounted at the given height. This will be reduced in the direction of motion due to normal initialisation constraints (See Applications Notes document IPU40184).
3. The green dashed lines indicates the preferred Minimum and Maximum Separations in 'Wide Opening Network' counter configurations. Counters should ideally be positioned at a distance between these two values, but in any case never further apart than the maximum.
4. The red dashed lines indicate the preferred Minimum and Maximum mounting distances from a door. Ideally the counter should be mounted between the max and min positions, but in any case should be mounted outside the arc of a swinging door.
5. Between 137" and 157", and between 275" and 295", counting accuracy may be reduced slightly for 40 degree units.

### IPU 40188 People Counter Mounting Height Graph Issue 8

Valid for all units in the 3000 series (outdoor only) People Counters.



20 Degree Units / Imperial

20° Field Of View						
Mounting Height Range (inches)	Typical Detection Region (inches)	Separation for Wide Opening (inches)		Optimum Distance Away From Door (inches)		
		Min	Max	Min	Max	
Absolute Minimum	275 3/5	79	59 3/8	74 2/9	39 3/8	39 1/2
<b>Recommended Range</b>	<b>315</b>	<b>90 1/6</b>	68 1/2	85 3/5	39 3/8	45
	<b>570 6/7</b>	<b>163 1/5</b>	127 5/8	159 1/2	65 2/7	81 3/5
Absolute Maximum	610 1/4	174 4/9	136 5/7	171	69 7/9	87 2/9

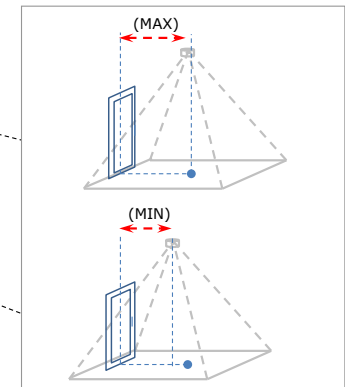
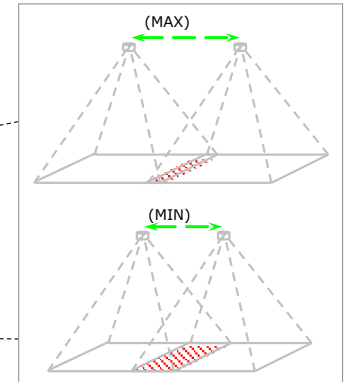
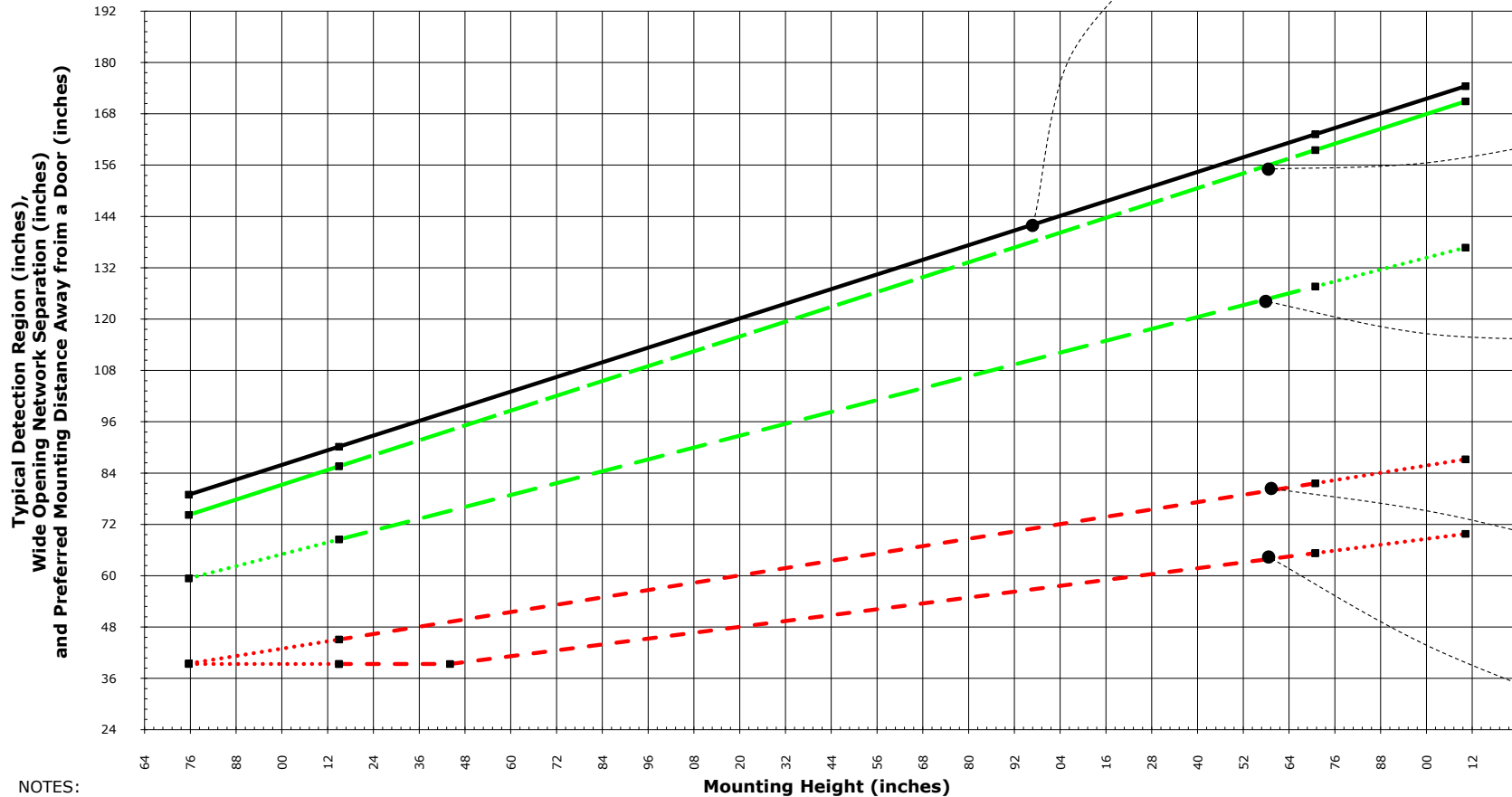
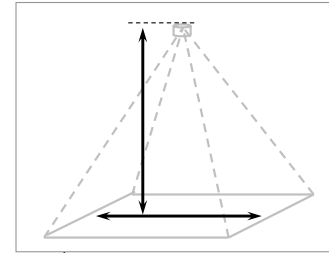

#### NOTES:

1. Always use the correct lens variant for the mounting height.
2. The solid black line indicates the Typical Detection Region which is maximum reliable coverage for a single counter mounted at the given height. This will be reduced in the direction of motion due to normal initialisation constraints (See Applications Notes document IPU40184).
3. The green dashed lines indicates the preferred Minimum and Maximum Separations in 'Wide Opening Network' counter configurations. Counters should ideally be positioned at a distance between these two values, but in any case never further apart than the maximum.
4. The red dashed lines indicate the preferred Minimum and Maximum mounting distances from a door. Ideally the counter should be mounted between the max and min positions, but in any case should be mounted outside the arc of a swinging door.
5. Between 275" and 315", and between 570" and 610", counting accuracy may be reduced slightly for 20 degree units.

**IPU 40188 People Counter Mounting Height Graph Issue 8**

Valid for all units in the Gazelle 2, Gazelle and 3000 series People Counters.

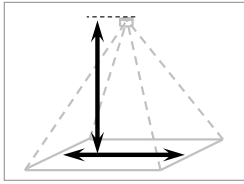

**90, 60, 40, & 20 Degree Units / Imperial**

90° Field Of View		
Mounting Height Range (inches)		Typical Detection Region (inches)
Absolute Minimum	98 3/7	125 1/3
<b>Recommended Range</b>	<b>98 3/7</b> <b>177 1/6</b>	<b>125 1/3</b> <b>241 3/8</b>
Absolute Maximum	177 1/6	241 3/8

60° Field Of View		
Mounting Height Range (inches)		Typical Detection Region (inches)
Absolute Minimum	86 3/5	77 2/3
<b>Recommended Range</b>	<b>98 3/7</b> <b>177 1/6</b>	<b>89 1/4</b> <b>166 1/3</b>
Absolute Maximum	189	178

40° Field Of View		
Mounting Height Range (inches)		Typical Detection Region (inches)
Absolute Minimum	137 4/5	78 5/6
<b>Recommended Range</b>	<b>157 1/2</b> <b>275 3/5</b>	<b>91</b> <b>164</b>
Absolute Maximum	295 2/7	176 1/8

20° Field Of View		
Mounting Height Range (inches)		Typical Detection Region (inches)
Absolute Minimum	275 3/5	79
<b>Recommended Range</b>	<b>315</b> <b>570 6/7</b>	<b>90 1/6</b> <b>163 1/5</b>
Absolute Maximum	610 1/4	174 4/9

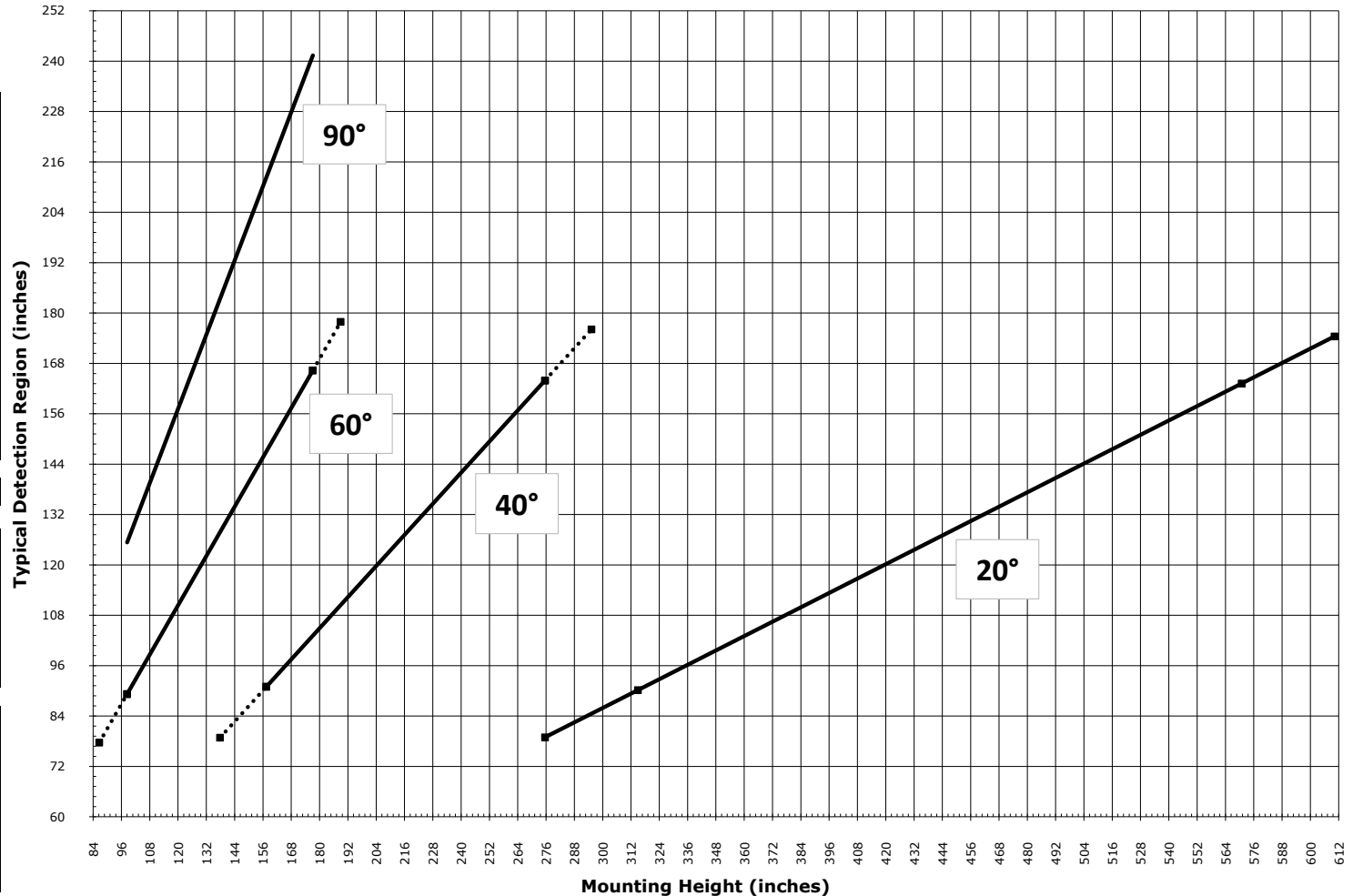

**NOTES:**

1. Always use the correct lens variant for the mounting height.
2. The solid black line indicates the Typical Detection Region which is maximum reliable coverage for a single counter mounted at the given height. This will be reduced in the direction of motion due to normal initialisation constraints (See Applications Notes document IPU40184).
3. The solid line endpoints indicate the recommended (preferred) mounting height range. Always install within this height range whenever possible.
4. The dashed line ends indicate the extended allowable height range. Changes to the counters discrimination sensitivity slider setting will be required at these heights.
5. Between 87" and 99", and between 177" and 189", counting accuracy may be reduced slightly for 60 degree units.
6. Between 137" and 157", and between 275" and 295", counting accuracy may be reduced slightly for 40 degree units.
7. Between 275" and 315", and between 570" and 610", counting accuracy may be reduced slightly for 20 degree units.