

GE Sensing Houston Center

Users Manual Printing & Assembly Instructions

PRINTING:

1. FRONT & BACK COVER PAGES:

Front and back cover pages (first and last pages) will be printed in color single sided on 8-1/2" x 11" 65lbs white paper.

2. INTRODUCTION PAGES:

Introduction section pages (up to Section 1.0) will be printed in color single sided on 8-1/2" x 11" 24lbs white paper.

3. SECTION AND APPENDIX PAGES:

All Sections and Appendix pages will be printed in color double sided on 8-1/2" x 11" 24lbs white paper.

ASSEMBLY:

Users Manual will be assembled with front and back 8-3/4" x 11-1/4" Clear View Plastic Covers bound with black spines of appropriate size.

PACKAGING:

The assembled Users Manual will be packed in a clear plastic bag or Saran wrapped. The package is labeled with bar coded part number as per purchase order.

(This page is not to be printed.)

GE Infrastructure
Sensing

Model 7750i

Air Data Test Set Users Manual



imagination at work

AIR DATA TEST SET MODEL 7750i USER'S MANUAL

GE INFRASTRUCTURE
SENSING

10311 WESTPARK DR.

HOUSTON, TEXAS 77042

(713) 975-0547 FAX: (713) 975-6338

e-mail: ruska@ruska.com ■ <http://www.Ruska.com>

Release: 7750-1D01

Revision: A

Date: 11/09/04

WARRANTY

GE Infrastructure Sensing warrants its products to conform to or exceed the specifications as set forth in its catalogs in use at the time of sale and reserves the right, at its own discretion, without notice and without making similar changes in articles previously manufactured, to make changes in materials, designs, finish, or specifications. GE Infrastructure Sensing warrants products of its own factory against defects of material or workmanship for a period of one year from date of shipment.

Liability of GE Infrastructure Sensing under this warranty shall be limited to replacing, free of charge (FOB Houston, Texas), any such parts proving defective within the period of this warranty, but will not be responsible for transportation charges or consequential damages.

This warranty is not made for products manufactured by others which are illustrated and described in GE Infrastructure Sensing catalogs or incorporated in GE Infrastructure Sensing products in essentially the same form as supplied by the original manufacturer. However, GE Infrastructure Sensing agrees to use its best efforts to have original suppliers make good their warranties.

COPYRIGHT NOTICE

Copyright © 2004 by GE Infrastructure Sensing. All rights reserved. This document may not be reproduced in part or in whole without the express written consent of GE Infrastructure Sensing.

DISCLAIMER

No representations or warranties are made with respect to the contents of this user's manual. Further, GE Infrastructure Sensing reserves the right to revise this manual and to make changes from time to time in the content hereof without obligation to notify any person of such revision.

TRADEMARK NOTICE



is a registered trademark of General Electric Corporation

Trademarks or trade names are subject to state and federal laws concerning their unauthorized use or other infringements. The fact that the product marks or names in this manual do not bear a trademark symbol DOES NOT mean that the product name or mark is not registered as a trademark or trade name. Any queries concerning the ownership or existence of any trademarks or trade names mentioned in this manual should be independently confirmed with the manufacturer or distributor of the product.

REVISION NOTICE

RELEASE NUMBER	REV.	DATE OF RELEASE	DESCRIPTION
7750-1D01	A	12/03/04	Original release per DC/RO-24557

7750i – Change Language

Hold **mode** key for 5 seconds

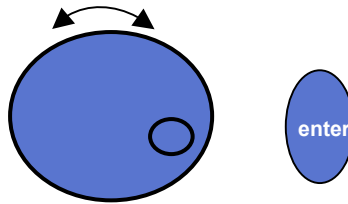

SAFETY SUMMARY

The following are general safety precautions that are not related to any specific procedures and do not appear elsewhere in this publication. These are recommended precautions that personnel must understand and apply during equipment operation and maintenance to ensure safety and health and protection of property.

KEEP AWAY FROM LIVE CIRCUITS

Operating personnel must at all times observe safety regulations. Do not replace components or make adjustments inside the equipment with the voltage supply connected. Under certain conditions, dangerous potentials may exist when the power control is in the off position due to charges retained by capacitors. To avoid injuries, always remove power from, discharge, and ground a circuit before touching it.

DO NOT SERVICE OR ADJUST ALONE

Do not attempt internal service or adjustment unless another person capable of rendering aid and resuscitation is present.

RESUSCITATION

Personnel working with or near dangerous voltages shall be familiar with modern methods of resuscitation. Such information may be obtained from your local American Medical Association.

ELECTRO STATIC DISCHARGE SENSITIVE PARTS

CAUTION: Electrostatic discharge sensitive (ESDS) is applied to low power, solid-state parts which could be damaged or destroyed when exposed to discharges of static electricity. Maintenance personnel are often not aware that an ESDS part has been damaged or destroyed because electrostatic discharges at levels less than 4,000 volts cannot be seen, felt, or heard.

COMPRESSED GAS

Use of compressed gas can create an environment of propelled foreign matter. Pressure system safety precautions apply to all ranges of pressure. Care must be taken during testing to ensure that all pneumatic connections are properly and tightly made prior to applying pressure. Personnel must wear eye protection to prevent injury.

PERSONAL PROTECTIVE EQUIPMENT

Wear eye protection approved for the materials and tools being used.

INERT GASES

Operation of pressure equipment may be accompanied by the discharge of inert gases to the atmosphere. The result is a reduction of oxygen concentration. Therefore, it is strongly suggested that exhaust gases not be trapped in the work area.

TABLE OF CONTENTS

WARRANTY.....	-ii-
COPYRIGHT NOTICE	-ii-
REVISION NOTICE.....	-iii-
CHANGE LANGUAGE.....	-iv-
SAFETY SUMMARY.....	-v-
TABLE OF CONTENTS.....	-vi-

SECTION 1.0: GENERAL INFORMATION

1.1 INTRODUCTION.....	1-1
1.2 GENERAL INFORMATION.....	1-1
1.3 FEATURES.....	1-1
1.4 STANDARD EQUIPMENT & OPTIONS.....	1-3

SECTION 2.0: THEORY OF OPERATION

2.1 INTRODUCTION.....	2-1
2.2 POWER SUPPLY.....	2-2
2.3 ELECTRONICS MODULE.....	2-2
2.3.1 BACK-PLANE BOARD.....	2-2
2.3.2 MICROPROCESSOR BOARD.....	2-2
2.3.3 DIGITAL CONTROL BOARD.....	2-3
2.3.4 IEEE-488 INTERFACE.....	2-3
2.3.5 FRONT PANEL.....	2-3
2.4 PNEUMATICS MODULE.....	2-4
2.4.1 MEASURE MODE PNEUMATICS.....	2-5
2.4.1.1 Qc REFERENCE.....	2-5
2.4.1.2 TEST PORT.....	2-5
2.4.1.3 GO TO GROUND OR VENT PROCEDURE.....	2-5
2.4.2 CONTROL MODE PNEUMATICS.....	2-5
2.4.2.1 PRESSURE SUPPLY PORT.....	2-5
2.4.2.2 VACUUM SUPPLY (EXHAUST) PORT.....	2-5
2.4.2.3 PRESSURE CONTROL.....	2-6
2.5 CONTROL STRATEGY.....	2-6
2.5.1 INNER VS OUTER LOOPS.....	2-6
2.6 TRANSDUCER MODULE.....	2-6
2.6.1 QUARTZ BOURDON TUBE SENSOR.....	2-6
2.6.2 SENSOR BOARD.....	2-6
2.6.3 LINEARIZATION TERM.....	2-7
2.6.4 AUXILIARY SENSORS.....	2-8
2.7 SOFTWARE.....	2-8
2.7.1 SOFTWARE SAFETY CONTROLS.....	2-8
2.7.1.1 PREVENTING OPERATOR ERRORS.....	2-8
2.7.1.2 PNEUMATIC ERRORS.....	2-8
2.7.1.3 SHUT OFFS.....	2-8
2.7.1.4 OVEN CONTROL.....	2-9
2.7.1.5 PRESSURE READING AND CORRECTION.....	2-10

SECTION 3.0: INSTALLATION

3.1	INTRODUCTION	3-1
3.2	UNPACKING THE ADTS	3-1
3.3	CAUTIONS.....	3-2
3.4	POWERING UP THE ADTS.....	3-2
3.4.1	OBSERVING THE ADTS'S FULL SCALE RATING	3-2
3.5	PNEUMATIC CONNECTIONS	3-2
3.5.1	PRESSURE SUPPLY PORT.....	3-2
3.5.2	EXHAUST PORT.....	3-3
3.5.3	TEST PORTS.....	3-3
3.5.4	VACUUM SUPPLY PORT	3-3
3.5.5	VACUUM SENSOR.....	3-3

SECTION 4.0: LOCAL OPERATION

4.1	DUAL CHANNEL DISPLAY SCREEN.....	4-3
4.1.1	CONTROL Ps AND CONTROL Qc	4-3
4.1.2	GO TO GROUND.....	4-3
4.1.3	LEAK TEST	4-3
4.1.4	SINGLE CHANNEL DISPLAY SCREEN	4-4
4.2	TUTORIAL.....	4-4
4.2.1	CHANGING UNITS OF MEASURE.....	4-5
4.2.2	SELECTING LANGUAGE.....	4-6
4.3	CONTROLLING PRESSURE	4-7
4.3.1	SETTING THE PRESSURE SET POINT	4-7
4.3.2	ENTERING/EXITING CONTROL MODE	4-7
4.4	VENT.....	4-8
4.5	STEP JOG	4-8
4.5.1	STEPPING	4-8
4.5.1.1	SETTING STEP SIZE.....	4-8
4.5.2	JOGGING.....	4-8
4.6	MENU	4-8
4.6.1	MENU SETUP.....	4-9
4.6.1.1	MENU SETUP - LIMITS	4-9
4.6.1.1.1	HIGH LIMIT.....	4-10
4.6.1.1.2	LOW LIMIT.....	4-10
4.6.1.1.3	AUTO VENT	4-10
4.6.1.1.4	CONTROL BAND	4-10
4.6.1.1.5	ARINC 565 OPERATING LIMITS.....	4-11
4.6.1.1.6	SUPPLY CORRECTION.....	4-11
4.6.1.1.7	SLEW RATE	4-12
4.6.1.1.8	SLEW LIMIT	4-12
4.6.1.1.9	NEGATIVE Qc LIMIT	4-12
4.6.1.1.10	ACCESS.....	4-12
4.6.1.2	MENU SETUP - USER.....	4-12
4.6.1.2.1	STEP SIZE.....	4-13
4.6.1.2.2	BAR GRAPH MAXIMUM.....	4-13

4.6.1.2.3	READY TOLERANCE.....	4-13
4.6.1.2.4	GAS HEAD PRESSURE CORRECTION.....	4-13
4.6.1.2.5	ATMOSPHERE.....	4-14
4.6.1.2.6	PRESSURE FILTER.....	4-14
4.6.1.2.7	CHANGING THE NUMBER OF DECIMALS.....	4-14
4.6.1.2.8	KEY CLICK.....	4-14
4.6.1.3	MENU SETUP - UNITS.....	4-15
4.6.1.4	MENU SETUP - REMOTE.....	4-16
4.6.1.4.1	GPIB ADDRESS.....	4-16
4.6.1.4.2	PROTOCOL.....	4-16
4.6.1.4.3	SERIAL INTERFACE SET-UP.....	4-16
4.6.1.5	MENU SETUP - SYSTEM.....	4-16
4.6.1.5.1	DATE TIME.....	4-17
4.6.1.5.2	RESET.....	4-17
4.6.2	MENU CALIBRATE.....	4-17
4.6.2.1	CALIBRATION PASSWORD.....	4-18
4.6.2.2	ZEROING.....	4-18
4.6.3	MENU TEST.....	4-19
4.6.3.1	MENU TEST - SWEEP TEST.....	4-19
4.6.3.2	MENU TEST - SELF TEST.....	4-20
4.6.3.3	MENU TEST - REMOTE TEST.....	4-20
4.6.3.4	MENU TEST - SHOP 1.....	4-20
4.6.3.5	MENU TEST - CONTROL.....	4-21
4.6.4	MENU DISPLAY.....	4-21
4.6.4.1	MENU DISPLAY - TEMPERATURE.....	4-22

SECTION 5.0: REMOTE OPERATION

5.1	CAPABILITIES.....	5-1
5.1.1	IEEE-488.....	5-1
5.1.2	RS-232.....	5-1
5.2	REMOTE/LOCAL OPERATION.....	5-2
5.3	CONFIGURATION.....	5-2
5.4	DEVICE MESSAGES.....	5-3
5.4.1	SCPI COMMAND FORMAT.....	5-3
5.4.2	SCPI RESPONSE FORMAT.....	5-3
5.4.3	ANSI/IEEE 488.2-1987 COMMAND SUMMARY.....	5-4
5.4.4	SCPI COMMAND SUMMARY.....	5-4
5.4.5	EXAMPLE SCPI COMMANDS.....	5-9
5.4.6	SCPI STATUS REGISTERS.....	5-9
5.5	SERIAL OPERATION.....	5-11
5.6	SAMPLE PROGRAMS.....	5-11
5.6.1	SAMPLE PROGRAM 1 - 7750i GPIB (IEEE-488) - CONTROLS PRESSURE TO 20.000%FS.....	5-11
5.6.2	SAMPLE PROGRAM 2 - 7750i GPIB (IEEE-488) - ZERO SEQUENCE.....	5-13
5.6.3	SAMPLE PROGRAM 3 - 7750i SERIAL (RS-232) - CONTROLS	

PRESSURE TO 20.000%FS	5-16
5.6.4 SAMPLE PROGRAM 4 - QBASIC EXAMPLE FOR 7750i	5-20

SECTION 6.0: MAINTENANCE

6.1 INTRODUCTION	6-1
6.2 OBSERVING THE SOFTWARE VERSION NUMBER	6-1
6.3 PREVENTIVE MAINTENANCE	6-1
6.3.1 INITIATING THE ADTS's SELF TEST	6-1
6.3.2 REMOVING THE ADTS's COVER	6-2
6.3.3 MOISTURE FILTER	6-2
6.3.4 PARTICLE FILTERS	6-2
6.3.5 VACUUM PUMPS	6-2
6.3.6 PROCESSOR BATTERY	6-3
6.4 CALIBRATION	6-3
6.4.1 CALIBRATION INSTRUCTIONS	6-3
6.4.1.1 PREPARATION	6-4
6.4.1.2 STORING THE COEFFICIENTS	6-6
6.4.2 VACUUM SENSOR CALIBRATION - Ps ZEROING VACUUM SENSOR	6-6
6.4.5 EDITING THE CALIBRATION COEFFICIENTS	6-7
6.4.6 ZEROING	6-8
6.4.6.1 Qc CHANNEL	6-8
6.4.6.2 Ps ABSOLUTE SENSOR	6-9
6.5 SENSOR PHOTOCCELL ZEROING	6-10
6.6 OPTIMIZING CONTROL	6-12
6.7 FAN OPERATION	6-14
6.8 SYSTEM SOFTWARE UPDATE PROCEDURE	6-15
6.8.1 MODEL 7750i CONTROLLER SOFTWARE UPGRADE	6-15
6.9 REPLACEMENT PARTS	6-16

SECTION 7.0: PREPARATION FOR STORAGE & SHIPMENT

7.1 DISCONNECTING THE ADTS	7-1
7.2 PACKING INSTRUCTIONS	7-1
7.3 SHIPPING INSTRUCTIONS	7-3

APPENDIX A: SUMMARY OF SPECIFICATIONS

A. UNCERTAINTY ANALYSIS	A-1
A.1 PERFORMANCE SPECIFICATIONS	A-1
A.2 LONG TERM STABILITY	A-1
A.3 SHORT TERM STABILITY	A-2
A.4 UNCERTAINTY OF THE STANDRD	A-2
A.5 ENVIRONMENTAL OR INSTALLATION INFLUENCES	A-2
A.6 ABSOLUTE ZEROING REFERENCE SESNOR	A-2
A.7 COMBINING THE UNCERTAINTY COMPONENTS INTO AN EXPANDED UNCERTAINTY STATEMENT	A-2
A.8 CONTROLLER SPECIFICATION	A-3
A.9 SPECIFICATIONS	A-6

APPENDIX B: SUMMARY OF ERROR MESSAGES	B-1
--	------------

LIST OF FIGURES

FIGURE 2-1:	ADTS BLOCK DIAGRAM	2-1
FIGURE 2-2A	MODEL 7750i ADTS PNEUMATICS DIAGRAM.....	2-4
FIGURE 2-2B	SOLENOID VALVE STATES	2-4
FIGURE 2-3:	SHAFT/MAGNET SECTION.....	2-7
FIGURE 2-4:	PHOTOCELL/LIGHT SPOT	2-7
FIGURE 3-1:	MODEL 7750i BACK PANEL	3-3
FIGURE 4-1:	MODEL 7750i FRONT PANEL	4-1
FIGURE 4-2:	MENU TREE	4-2
FIGURE 4-3:	AIRSPEED (Knots).....	4-12
FIGURE 6-4:	VACUUM (NEGATIVE GAUGE) CALIBRATION	6-7
FIGURE 6-5:	PHOTOCELL LOCATION.....	6-12
FIGURE 7-1:	PACKING THE ADTS	7-3

LIST OF TABLES

TABLE 1-1:	OPTIONS LIST FOR THE MODEL 7750i ADTS.....	1-3
TABLE 2-1:	CONVERSION FACTORS	2-3
TABLE 2-2:	SOLENOID VALVE STATES	2-5
TABLE 3-1:	GENERAL SPECIFICATIONS: GENERAL PARAMETERS	3-1
TABLE 6-1:	ELECTRONICS SELF TEST	6-2

SECTION 1.0 GENERAL INFORMATION

1.1 INTRODUCTION

This manual contains operation, routine and preventive maintenance instructions for the Model 7750i Air Data Test Set (ADTS) manufactured by GE Infrastructure Sensing, Houston, Texas. This section of the manual provides general information about the ADTS and presents its features and options.

1.2 GENERAL INFORMATION

The GE Model 7750i ADTS uses force-balanced, fused-quartz Bourdon tube technology to provide the precise measurement of pressure. During normal operation, the ADTS performs in either Measure mode or Control mode.

In Control mode, the ADTS simultaneously measures and controls pressure. Control mode is commonly used in the calibration and testing of pressure gauges, transducers, pressure switches, and production pressure instruments.

In Measure mode, the ADTS measures pressure. Typically, Measure mode applications are found in research laboratories, wind tunnel testing, power plant testing, and bubbler tank volume accountancy systems. It is also used to monitor barometric pressures, vacuum systems, and differential pressure devices.

The 7750i has two full scale pressure ranges and two pressure controllers integrated into one instrument.

1.3 FEATURES

The following features are available on all Model 7750i ADTS's.

Fused-Quartz Bourdon Tube Technology: GE's force-balanced, fused-quartz Bourdon tube sensor makes use of the stability, high elasticity, low hysteresis, and excellent fatigue strength of fused quartz. This time-proven technology eliminates the need for gear trains, bearings, shafts, and other moving parts that can wear out or introduce hysteresis or deadband into the process.

Mercury-Free: All components in the ADTS are mercury-free.

NIST Traceability: All ADTS's are calibrated using GE deadweight gauges which are directly traceable to the National Institute of Standards and Technology (NIST). GE is also a NVLAP accredited laboratory and therefore can provide an optional NVLAP accredited calibration.

Universal Power Supply: The ADTS's universal power supply accepts AC voltages between 90 and 260 volts, and DC voltages between 100 and 370 volts. To "reconfigure" the ADTS for use in another country, the user simply changes the power cord.

Measure While Control: The ADTS simultaneously digitally displays the commanded pressure, the actual pressure, and the difference between the two. A bar graph indicates how close the actual pressure is to the commanded pressure, as well as how close the commanded pressure is to the ADTS's full scale pressure.

Friendly Display: The ADTS's color active matrix TFT display combines a bright, low-glare readout with a wide viewing angle. During normal operation, the measured pressure is easily visible from a distance of 10 feet (3 meters).

Adjustable Pressure Display: The pressure display may be adjusted to show one decimal greater than or less than the default resolution.

Ease of Operation: An intuitive, menu-driven interface makes the ADTS easy to use. Frequently used selections such as the units of measure are restored to memory each time the ADTS powers up.

Easily Programmable: The ADTS's powerful microprocessor provides the basis for smart electronics. With a few simple keystrokes, the user can set limits on the system pressure, create unique units of measure, program a test sequence, and more.

Modular Design: The sensing element, pneumatics, electronics, and user interface are separated into modules, making maintenance faster and easier.

Attractive Desktop Packaging: A sturdy aluminum case houses all of the ADTS's pneumatics, electronics, and user controls. With the optional rack mount kit, this standard 19" EIA chassis fits easily into a rack mount system.

Power On Self Test: Upon power-up, the ADTS quickly tests its hardware and software. After the ADTS completes this test, the user can select more extensive self-tests for the pneumatics and electronics.

Ease of Calibration: Calibration may be performed either remotely or entirely from the front panel. No disassembly is required, and there are no potentiometers to tune. On single sensor units, only a three-point calibration is required to fully characterize the instrument. On instruments that integrate multiple ranges such as the 7750ii, additional calibration points are required.

Automatic Zero Adjust: At the user's request, the ADTS's software automatically performs the zero adjustment, with no potentiometers to tune.

Automatic Head Correction: The ADTS automatically corrects for head pressure between the ADTS and the device under test (DUT), taking into account the density of the test gas; e.g., air or nitrogen.

Choice of Medium: Although the ADTS is not sensitive to the type of gas used within the system, the user can select either instrumentation air or nitrogen, allowing the ADTS to automatically make pressure head corrections.

Choice of Display Units: Standard units include inHg at 0°C and 60°F, kiloPascals, bars, psi, inH₂O at 4°C, 20°C, and 25°C, kilograms per square centimeter, mmHg, cmHg at 0°C, and cmH₂O at 4°C. Altitude and airspeed units include feet, meters, mach, knots, and kilometers per hour. In addition to these predefined units, four user-defined units are programmable.

Communications Interface: The ADTS includes standard RS-232 serial and IEEE-488 interfaces. The user's computer communicates with the ADTS through the Standard Commands for Programmable Instruments (SCPI) protocol.

1.4 STANDARD EQUIPMENT & OPTIONS

A standard ADTS includes this manual and a power cord. Although the standard ADTS is fully functional with just these items and the appropriate pressure and vacuum supplies, the following options are also available.

NVLAP Accredited Calibrations - GE received formal accreditation from the National Voluntary Laboratory Accreditation Program (NVLAP) which is administrated by the National Institute of Standards and Technology (NIST). NVLAP has assigned laboratory code 200491-0 to indicate that our accredited calibration services are in compliance with all relevant requirements of ISO/IEC 17025:1999 and ISO 9002:1994. GE's calibration laboratory can provide an optional accredited pressure calibration. The NVLAP calibration certifications are optional and must be requested at time of order.

Rack Mount Kit: This 6.969" kit meets ANSI/EIA requirements for a 4U, 19" rack mount kit.

Lines and Fittings Kit: This kit contains that pressure and vacuum lines and fittings to connect the 7750i or 7750ii to the optional GE Infrastructure Sensing vacuum pump and to a bottle regulated with ¼ inch NPT fittings. Additionally, this kit contains two flexible hose assemblies, one for the Ps terminating to a female AN6 fitting and one for the Qc pressure port terminating to a female AN4 fitting.

Additional Power Cords: Additional power cords are available for most countries. All options are summarized in Table 1-1. To order these items, please contact GE Instrument Sales in the U.S. at (713) 975-0547.

**TABLE 1-1
OPTIONS LIST FOR THE MODEL 7750i ADTS**

Option	GE Infrastructure Sensing Houston Part Number
LabView Driver (National Instruments)	Downloadable from World Wide Web
Rack Mount Kit - Cabinets 18-24 inches deep	7250-903
Lines and Fittings Kit	7750-900
Vacuum Pump	
115 VAC 50/60 Hz	99877-800
230 VAC 50/60 Hz	99877-860
Power Cord - USA, Canada, Central Europe	16-81, 16-81, 16-86
Power Cord - India, Japan, Israel	16-96, 16-93, 16-97
Power Cord - Australia/New Zealand	16-95

NOTES

SECTION 2.0 THEORY OF OPERATION

2.1 INTRODUCTION

The ADTS's power supply, electronics, pneumatics, and sensor combine to form a complete, stand-alone, measure and control instrument. This section of the manual describes the ADTS's component modules (Figure 2-1) and provides a general discussion of each. The 7750i has two pneumatic control and two primary transducer modules.

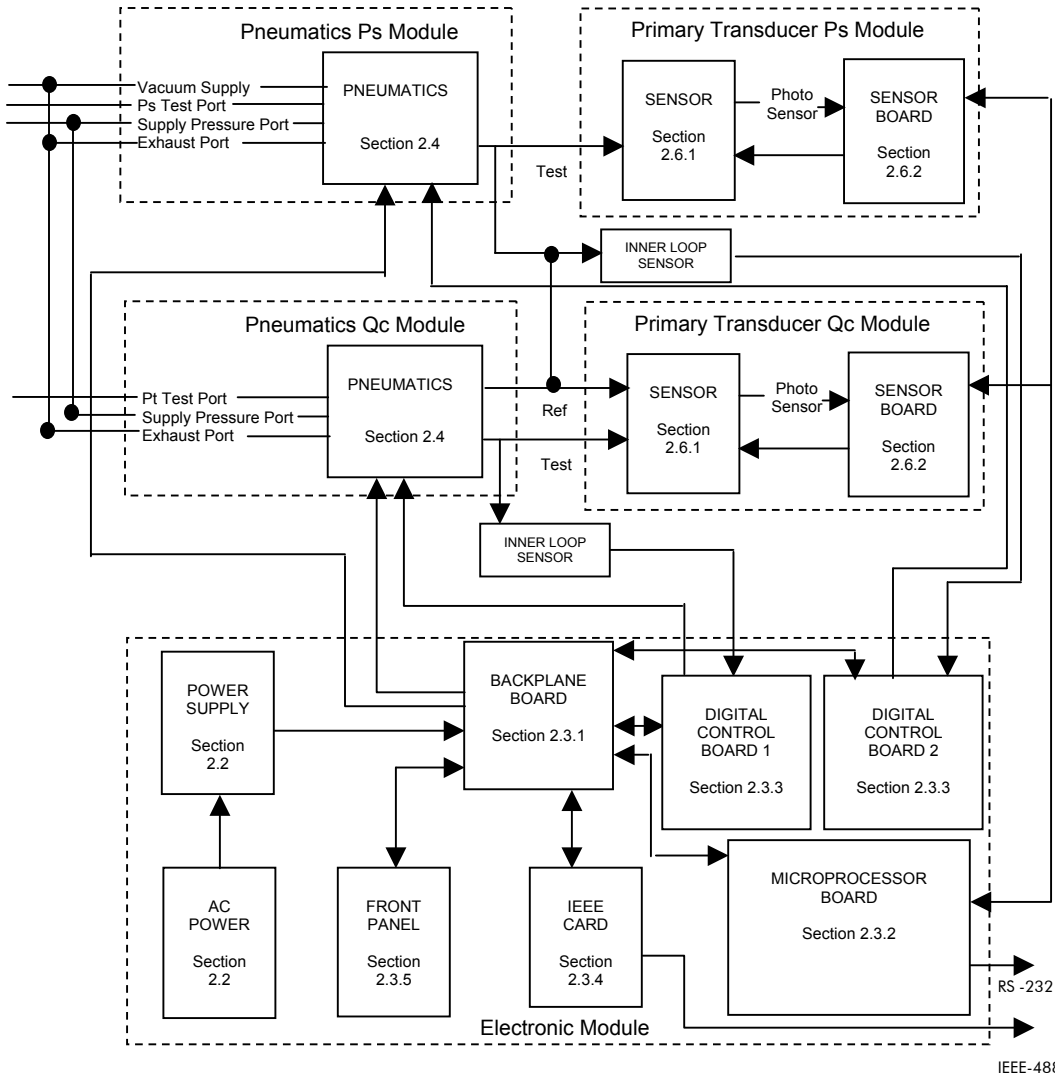

**FIGURE 2-1
ADTS BLOCK DIAGRAM**

2.2 POWER SUPPLY

The ADTS's universal power supply accepts AC voltages from 90 to 260 volts at 47-63 Hz. and DC voltages from 100 to 370 volts. This quad-output supply produces +5 VDC, +/-12 VDC, and 24 VDC which are distributed to the Control and Backplane Boards.

2.3 ELECTRONICS MODULE

2.3.1 BACK-PLANE BOARD

The Back-plane Board is used to interconnect all of the plug-in electronic boards and distribute power. The Microprocessor Board, the Digital Control Board, and the IEEE-488 Interface all plug into the Back-plane Board. The Front Panel communicates with the Microprocessor Board via cables. The Sensor Board communicates with the Microprocessor board through an internal RS-485 serial communication bus.

2.3.2 MICROPROCESSOR BOARD

All of the ADTS's software resides in nonvolatile, programmable, read-only memory (Flash EPROM) on the Microprocessor Board, which plugs directly into the Back-plane Board. This software contains all of the instructions that operate the ADTS, as well as the conversion factors that the ADTS uses to translate the internal pressure unit-of measure of kPa into the units selected by the user. These factors are given in Table 2-1.

Data that is subject to change after the ADTS leaves the factory are held in electrically erasable, programmable, read-only memory (EEPROM). This includes the current units of measure, the coefficients from the zeroing process, the current pressure medium, calibration coefficients, and the conversion factors for the four user-defined units of measure.

When the ADTS powers up, its software is loaded into random access memory (RAM), also on the Microprocessor Board. At the same time, the values stored in EEPROM Board are restored to memory.

Another important component on the Microprocessor Board is the lithium battery. The battery continuously updates the ADTS's date and time, even when the unit is powered down. This battery has a varying life. If the instrument is left on 24 hours a day, it may last 5 to 10 years. If the instrument is stored, it may only last one year.

The Microprocessor Board also supports the RS-232 serial interface that allows the user's computer to communicate with the ADTS.

**TABLE 2-1
CONVERSION FACTORS**

Unless specified otherwise, conversion factors are based on ANSI 268-1982.

Symbol	Description	Conversion Factor
InHg	inches of mercury (0 °C)	= kPa x 0.2952998
InHg	inches of mercury (60 °F)	= kPa x 0.296134
KPa	KiloPascals	= kPa x 1.0
Bar	Bars	= kPa x 0.01
Psi	pounds per square inch	= kPa x 0.1450377
cmH ₂ O	Centimeters of water (4 °C)	= kPa x 10.19744
inH ₂ O	inches of water (4 °C)	= kPa x 4.014742
kg/cm ²	kilograms per square centimeter	= kPa x 0.0101972
mmHg	Millimeters of mercury (0 °C)	= kPa x 7.500605
cmHg	Centimeters of mercury (0 °C)	= kPa x 0.7500605
knots	indicated airspeed	per NASA TN D-822
km/hr	kilometers per hour	= knots x 1.852
Feet	feet of altitude	per MIL-STD-859A
meters	meters of altitude	per MIL-STD-859A
User1	user defined	= kPa x user defined
User2	user defined	= kPa x user defined
Pa	user defined (Pascals)	= kPa x 1000.0
hPa	user defined (hectoPascals)	= kPa x 10.0
%FS	percent of full scale	

2.3.3 DIGITAL CONTROL BOARD

The Digital Control Board plugs directly into the Back-plane Board. This board reads a high speed silicon strain gauge pressure transducer, PDCR, connected to the pressure generation point. A digital controller on the board drives two solenoids in the pneumatics section to form a high speed, closed loop controller. There are two digital control boards in the 7750i ADTS.

2.3.4 IEEE-488 INTERFACE

The ADTS's IEEE-488 (GPIB) interface card, which plugs directly into the Back-plane Board, provides the ADTS with an IEEE-488 interface. This interface allows the user to automate the measurement and control processes.

2.3.5 FRONT PANEL

The Front Panel contains the active matrix TFT color display, rotary knob and rubberized keys used to operate the ADTS.

2.4 PNEUMATICS MODULE

The ADTS's Pneumatics Module include an Absolute mode pneumatic module for the Ps channel and a differential pneumatic module for the Qc Channel. The Output of the Ps channel controls the pressure to the reference of the Qc differential channel. The Total Pressure (Pt) value is derived from the addition of the Ps and Qc sensor values.

The valves, filters, and transducers that make up the pneumatics module are shown in Figures 2-2.

In the sections that follow, the Zero, Isolation, Apply and Release valves are all 24-volt, DC solenoid valves that are either open or closed depending on the ADTS's operational mode. Their behavior is summarized in Table 2-2.

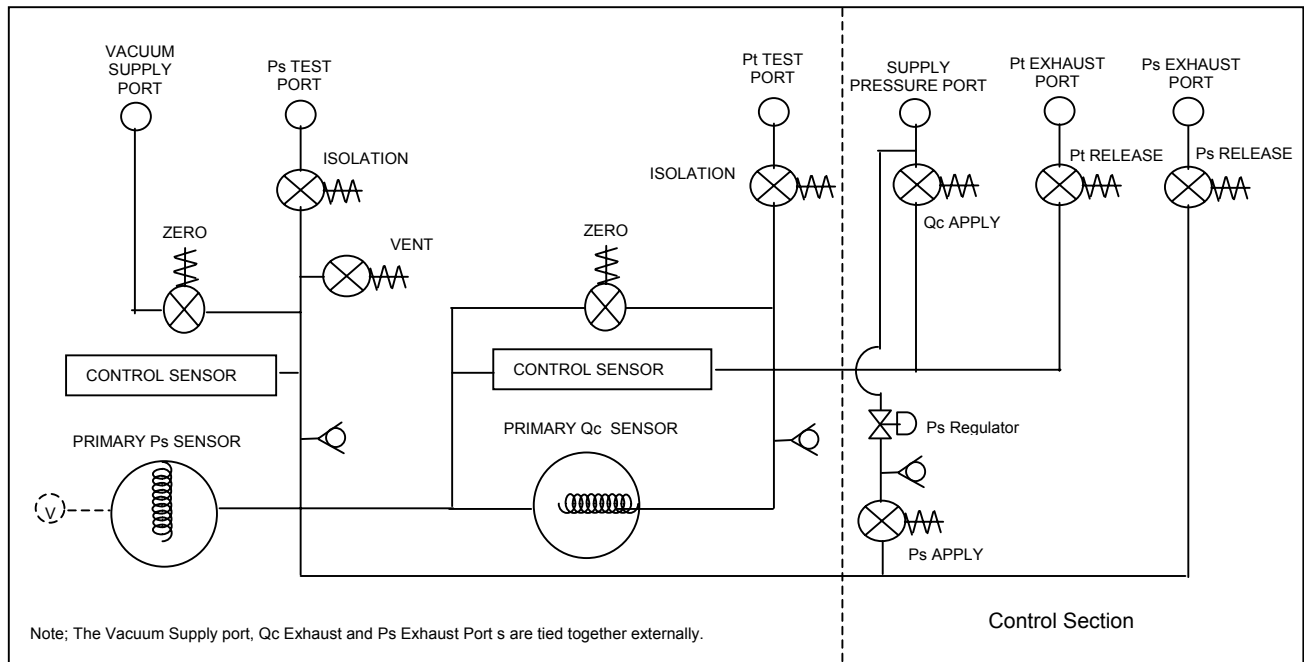

**FIGURE 2-2A
MODEL 7750i ADTS PNEUMATICS DIAGRAM**

Valve	Measure Mode	Vent	Control Mode	Zeroing
Test Port Isolation	open	open	open	closed
Zero	closed	closed - open	closed	open
Vent	closed	closed - open	closed	closed
Apply	closed	closed	modulate	closed
Release	closed	open - closed	modulate	closed

**TABLE 2-2B
SOLENOID VALVES STATES**

2.4.1 MEASURE MODE PNEUMATICS

Figure 2-2 summarizes the Pneumatics of the ADTS.

2.4.1.1 Qc Reference

The Reference side of the true differential Qc sensor is internally tied to the test port of the Ps sensor.

The Reference side of the Qc sensor is isolated from the Pt Test Port by a solenoid valve that is closed during the ADTS's Measure and Control modes. When the user commands the ADTS to perform the zeroing process, the solenoid automatically opens, and the pressures on the Reference and Test Ports of the Qc sensor become equal. On the permanent absolute Ps sensor, the Ps zeroing valve allows a vacuum to be pulled onto the Ps test port allowing the instrument to zero at a low vacuum level.

2.4.1.2 Test Port

The Test Port connects the DUT to the Pneumatics Module. The 7750i has two test ports, one for the Ps and for the Pt channel. The Test Port is isolated from the DUT by a normally closed solenoid valve that is open during the ADTS's Measure, Control and Vent modes and closed during the zeroing process.

Each Test Port is protected by a relief valve.

2.4.1.3 Go To Ground or Vent Procedure

The Go-To-Ground and vent modes are implemented with multi-step procedures. The ADTS controls pressure at the user defined rate towards atmospheric pressure. When the primary sensor reads that the pressure is near atmospheric pressure, the controller is turned off and the Qc zeroing solenoid is opened which equalizes the differential pressure in the Qc sensor and then once the Ps sensor is near atmosphere, the internal vent valve is open which vents the entire system to atmosphere.

2.4.2 CONTROL MODE PNEUMATICS

2.4.2.1 Pressure Supply Port

The Pressure Supply Port connects the user's regulated gas supply to the Pneumatics Module. Please refer to Appendix A for gas specifications and supply pressure limits. One supply pressure is connected to the lower left hand pressure port of the rear chassis. This regulated pressure should be set to 4 bar. Internally, this pressure is regulated down further to supply the Ps control manifold.

2.4.2.2 Vacuum Supply (Exhaust) Port

The Ps and Pt Exhaust Ports are externally tied to the vacuum supply port allowing the technician to operate the system with a single vacuum pump. Select a vacuum pump with the test port volumes and system slew rates in consideration. A high capacity vacuum pump is required to allow the unit to be zeroed. The minimum requirements are noted in Appendix A. The vacuum pump must be fitted with an auto-vent solenoid valve that vents the vacuum to atmosphere when the pump loses power.

2.4.2.3 Pressure Control

Pressure control is performed by a dual-loop control system. The inner loop is a digital loop using a high frequency response silicon strain gauge sensor, a digital controller, and two pulse-width modulated solenoids. The two solenoids either add gas to the test port or remove it. The outer loop provides closed-loop control, based on feedback from the quartz Bourdon tube and an analog output setting which provides the desired set-point for the inner loop.

2.5 CONTROL STRATEGY

2.5.1 INNER VS. OUTER LOOPS

The inner loop accepts a signal from the outer loop and uses this signal as the pressure set-point. The inner loop uses a high frequency response strain gauge sensor as its reference. The frequency response of this transducer allows for high speed modulation of the solenoids. This sensor is aligned to the high accuracy quartz sensor when the system is Auto-tuned.

The outer loop is a lower frequency response, analog-digital loop. The outer loop uses a calibrated, forced-balanced sensor. This sensor is used to monitor the pressure of the system. The results are used for the displayed pressure. The outer loop is responsible for adjusting the signal sent to the inner loop to compensate for temperature and time drifts associated with the inner loop sensor.

2.6 TRANSDUCER MODULE

2.6.1 QUARTZ BOURDON TUBE SENSOR

The quartz Bourdon tube sensor is mounted in a machined aluminum housing. The sensor consists of a helical quartz tube with a mirror affixed to one end, as shown in Figure 2-5.

A rigid beam is attached transverse to the axis of the helical tube. Attached to both ends of this beam are electromagnetic coils. Mounted beneath the coils are permanent magnets. A lamp assembly directs light through a quartz or sapphire window onto the mirror affixed to the helical tube, as shown in Figure 2-6. The mirror reflects the light back through the window and strikes two matching photodiodes. When there is zero pressure differential across the helical tube, the photodiode assembly is mechanically adjusted so that the light spot is centered between each photocell. In this "zero position," the outputs of the two photodiodes provide energy used to maintain the quartz assembly in its zero position; thus, a force balance is created.

As pressure is applied in the helical tube, the entire apparatus attempts to rotate. This causes the mirror to move the reflected light spot to shine more on one photodiode than the other. The Sensor Board (see Section 2.6.2) then responds by changing the current to the electromagnetic coils that, through interaction with the permanent magnets, force the helical tube to return to its zero position. The amount of current required to do this is proportional to the pressure applied across the helical tube. Thus, the pressure is determined by the amount of current required to return the helical tube to its zero position.

On the Absolute Ps sensor, the process is similar, except that the Bourdon tube is permanently evacuated and sealed at the factory, and the test pressure is applied to the

sensor case. With this configuration, all test pressures are measured with respect to vacuum.

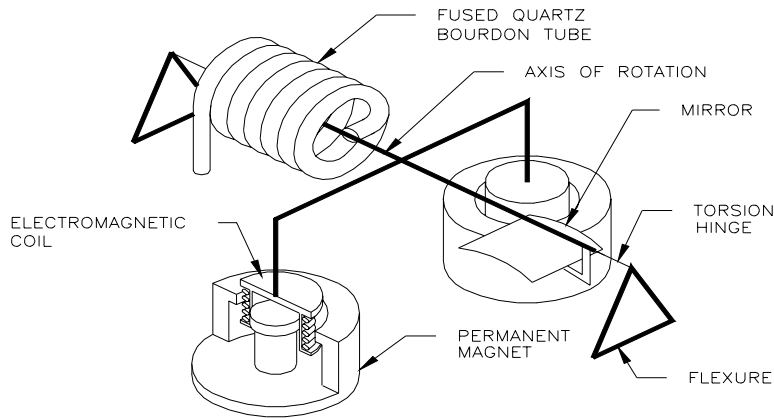

**FIGURE 2-3
SHAFT/MAGNET SECTION**

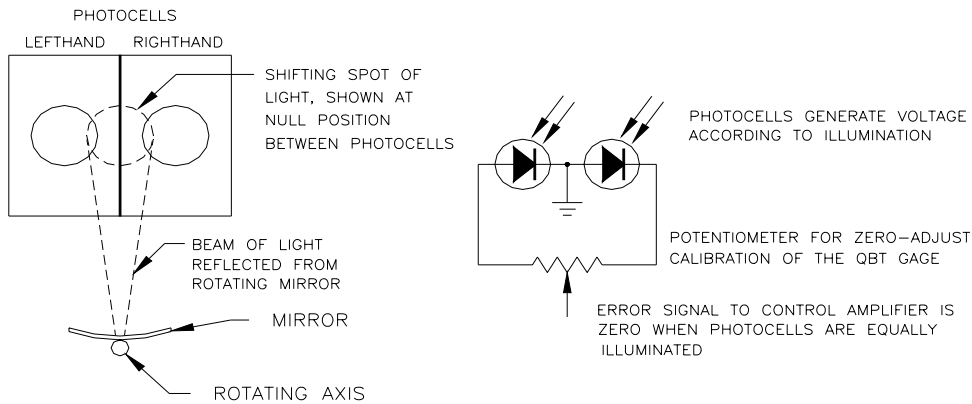

**FIGURE 2-4
PHOTOCELL/LIGHT SPOT**

2.6.2 SENSOR BOARD

A temperature sensor and the quartz Bourdon tube pressure sensor are monitored by the Sensor Board. The Sensor board is also used to control and maintain the sensor housing at 50°C.

2.6.3 LINEARIZATION TERM

As described in the previous section, the relationship between the pressure being measured and the current required to keep the quartz Bourdon tube in its zero position is the main principle behind the operation of the ADTS's sensing element.

Ideally this pressure-current relationship would be a linear equation of the form

$$I = kP,$$

where I is current, k is a constant of proportionality, and P is pressure. However, due to certain mechanical characteristics of the helical tube and its supporting structure, this pressure-current relationship is slightly nonlinear. The nonlinear portion of this pressure-current relationship closely follows the form of a second order polynomial, or

$$I = aP^2 + bP + c,$$

where again P is pressure and a, b, and c are coefficients generated during the calibration procedure as discussed below.

When the user performs a three-point calibration, the ADTS's software creates the three coefficients based on the user's zero, mid-point, and full-scale adjustments. From then on, the nonlinear term given above is subtracted from the total pressure-current curve to achieve the desired linear pressure-current relationship.

On the 7750ii, multiple quartz sensor ranges are used in order to provide the percent of reading specification. In these instruments, a total of three points per range with one point shared between two ranges is required. Therefore, for the 7750i, a 3 point calibration is performed and for the 7750ii, a 5 point calibration is performed to fully characterize the Ruska quartz sensors.

2.6.4 AUXILIARY SENSORS

Auxiliary sensors are sensors such as the oven temperature and reference vacuum sensors. These are reference sensors aligned at the factory and are utilized by the firmware.

2.7 SOFTWARE

The ADTS is a digital, software-based instrument. The controlling software uses a PID algorithm and allows for user-definable units and onboard programming. The software control loop is a digital outer loop with a high-speed inner loop.

2.7.1 SOFTWARE SAFETY CONTROLS

2.7.1.1 Preventing Operator Errors

The operator is required to verify a change to Control mode or Vent mode by pressing the [Enter] key. Additionally, the control set-point is set to zero on power-up or when any of the limit errors occur.

2.7.1.2 Pneumatic Errors

The ADTS continually monitors the pressure for low, high and slew (rate of change) limits. When these limits are exceeded, the ADTS is returned to Measure mode, shuts off the apply and exhaust control valves, and an error message is generated. Additionally a vent limit may be set. The ADTS will go to Vent mode when the pressure exceeds this limit.

2.7.1.3 Shut Offs

Measure mode can be entered at any time by pressing the Measure key on the main keypad with no further acknowledgment required. The ADTS will turn off the controller.

2.7.1.4 Oven Control

The oven temperature is controlled via a pulse-width modulated signal. The time the heater is on can be varied from 0 to 100%. The pulse-width at startup is initialized to the previous value which was stored in battery-backed CMOS RAM.

The oven control is a PID controller updated approximately every 7 seconds. The sensor readings are accessed by pressing MENU | DISPLAY. The high accuracy quartz sensor is housed in a temperature controlled oven. There is a 3 hour warm-up time required prior to the ADTS operating at its optimum precision. The user can verify when the instrument is thermally stable by viewing the MENU | DISPLAY screen and verifying that the temperature is at 50° C. In addition to the temperature, this screen will show the duty cycle of the oven.

When operating the system in either a very cold or hot environment, if the oven is unable to maintain the temperature of the internal oven, the ADTS will generate an Oven Control Failure error messages. The operator can review the temperature and duty cycle of the oven by pressing the MENU | DISPLAY keys. The unit must be have been warmed up for a minimum of 3 hours prior to determining the condition of the oven temperature control. The temperature of the sensor should be controlled to 50° C. The Duty Cycle indicates the amount of time (in units of percentage) that the oven control is turned on in order to maintain the oven at the proper set-point of 50° C. A unit that is operating properly, after it has fully warmed up, should indicate a sensor temperature of 50° C and a duty cycle between 10 to 90%.

If operating the instrument in a very cold environment and the oven duty cycle is at a high percentage (>90%) you will need to turn the fan off. If you are operating in a warm environment or when multiple systems are housed in consoles without adequate ventilation, the system may become too hot and generate the oven control failure error message. If operating the instrument in a warm environment and the oven duty cycle is at a low percentage (>10%) you will need to turn the fan on. See Section 6.7 for fan operation.

When the operator changes the status of the fan, it will remain in that condition until the operator changes the setting.

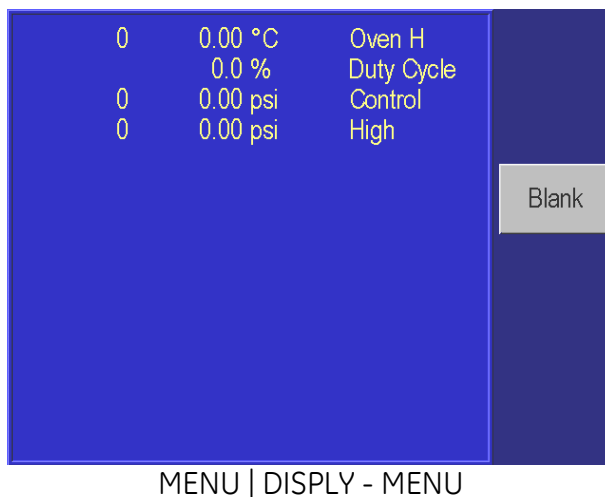

2.7.1.5 Pressure Reading and Correction

The sensor's analog output is processed by an analog-to-digital circuit that results in an output referred to as counts. This output is corrected for the applied effects listed below.

The counts are linearized and the resulting pressure value is corrected for the variations in head pressure, vacuum, case effect, and oven temperature effects.

The following equations are used by the control algorithm to adjust and correct the pressure signal.

Zero Coefficients

- CsH Zero correction for High FSR (Full-Scale Resistors) Value is in counts (7,381,975 = full scale of current sensor).
- CsL Zero correction for Low FSR. Value is in counts (7,381,975 = full scale of low FSR)
- HsZ Hardware zero correction. (0 to 4095, center is 2048).
- SsZ Zero corrections scaling factor. Ratio of High FSR to Low FSR. Used only when Case Effect Coefficient or Oven Temperature Coefficient are non-zero.

s=0 for high range sensor, s=1 for low range sensor.

Range Coefficients

- KnF 0=Range Unused
4=Valid High FSR Range
5=Valid Low FSR Range

Kn0, Kn1, Kn2 Calibration constants for range

$$B = \frac{K_{n2}}{2^{48}} * A^2 + \frac{K_{n1}}{2^{24}} * A + K_{n0}$$

Where A is the zero corrected counts (7,381,975 = full scale of current range) and B is the calibrated counts (7,381,975 = full scale of current sensor)

- KnH Zero corrected counts for upper limit of range. When the zero corrected counts from the A/D exceed this value the next higher range will be used (if possible). (7,381,975 = full scale of current range)
- KnL Zero corrected counts for lower limit of range. When the zero corrected counts from the A/D are below this value the next lower range will be used (if possible). (7,381,975 = full scale of current range)

n=Range number (1 - 4 for high range sensor, 5 - 8 for low range sensor)

SECTION 3.0 INSTALLATION

3.1 INTRODUCTION

This section of the manual discusses initial installation for the Model 7750i ADTS. Installing the ADTS involves connecting the supply and test pressure tubing, powering up the unit, and configuring the system through the front panel.

3.2 UNPACKING THE ADTS

Carefully unpack all components, checking for obvious signs of damage. The shipment contains the following items:

1. Model 7750i ADTS,
2. power cord,
3. user's manual,
4. calibration report,
5. user-specified instrument options.

If necessary, report any shipping damage to the freight agency. Remove all shipping and packing materials (including the shipping plugs) from all components. If possible, save the packing materials for future shipping needs.

Finally, install the ADTS in a location that meets the requirements listed in Table 3-1.

NOTE: The ADTS should be handled in such a way as to minimize mechanical shocks or vibration during installation or use. It should be mounted on a rigid bench or in a sturdy 19" rack. Although the zeroing process will compensate for a slightly unlevel mounting, the ADTS should be mounted to within 5° of level.

**TABLE 3-1
GENERAL SPECIFICATIONS: GENERAL PARAMETERS**

Parameter	Value	Model
Operating Humidity	5–95%RH, noncondensing	all
Storage Humidity	none*	all
Operating Temperature	18 – 36°C	all
Storage Temperature	-20 to 70°C	all
Electrical Power	90–260 VAC	all
Power Consumption	150 W	all
Warm-up Period	< 3 hrs	all

*If there is any condensation when storing the ADTS, it must be thoroughly dried before power is applied. It is also recommended to connect the reference port to the test port and evacuating these simultaneously to remove any moisture from the sensor.

3.3 CAUTIONS

The following cautions should be heeded at all times to ensure safe operation of the ADTS.

1. Never operate the ADTS with the cover removed. The power supply has internal voltages near 400 volts.
2. For each channel, never apply more than 120% of the ADTS's channel full scale as a pressure supply. Both pressure supplies must be regulated and meet all of the criteria stated in Appendix A of this manual.
3. Never apply more than 110% of the ADTS's full scale to the test port of each channel. Never try to control while a pressure source is connected to the test port.
4. Do not expose the instrument to thermal and mechanical shock, or vibration. This may affect performance and require re-zeroing.
5. See the safety summary in the introduction.

3.4 POWERING UP THE ADTS

First, plug the power cord supplied with the ADTS into the power connector on the ADTS's back panel.

CAUTION: Grounding for the ADTS is provided through the power cord.

Next, plug the power cord into a receptacle rated for any AC voltage between 90 and 260 volts. If a different power cord is necessary for your receptacle, consult Table 1-1 for available power cords.

Finally, turn on the ADTS by toggling the power switch on the back panel. When the MEASURE screen appears on the display, the front panel will be fully operational.

3.4.1 OBSERVING THE ADTS'S FULL SCALE RATING

The full scale pressure range of each channel of the ADTS is noted on a label on the front panel of the instrument. The label denotes the pressure range for Ps and for the Qc channel.

3.5 PNEUMATIC CONNECTIONS

The following sections discuss each port. All ports are ¼-inch NPT pipe fittings. See Figure 3-1. Remove all plastic shipping plugs from the back panel pneumatic ports.

3.5.1 PRESSURE SUPPLY PORT

A single pressure regulated pressure supply source of clean, dry nitrogen or air should be supplied to the instrument. Shop air should not be used. Refer to Appendix A for supply port gas purity and pressure regulation requirements.

Tubing must be of at least 1/8-inch (3-mm) inside diameter and of a sufficient wall thickness for the pressure.

3.5.2 EXHAUST PORT

The two exhaust ports are connected to the vacuum supply port externally to the ADTS. A single vacuum pump is required to operate the ADTS. Supply vacuum lines must have minimum restrictions. Tubing should have a minimum I.D. of ¼ inch. It is highly recommended to have vacuum lines with outside dimensions of ½ to ¾ inches. Additionally, the length of the vacuum hose should be minimize for maximum performance. It is also very important to install an auto-vent valve to the vacuum pump. The purpose of the valve is to vent the vacuum to atmosphere when the pump is turned off.

3.5.3 TEST PORTS

The device(s) under test is connected to the test port. The ADTS controller is designed to operate within its specification limits into load volumes from 5 to 60 in³ (80 to 1000 cc). Excessive leaks in the test volume will cause measurement errors in the device under test and may possibly affect control stability. Tubing connected from the test port to the load volume should have an internal diameter greater than 1/8 inches (3 mm).

3.5.4 VACUUM SUPPLY PORT

The two exhaust ports are connected to the vacuum supply port externally to the ADTS.

To zero the Ps channel, a vacuum pump capable of producing a vacuum level of 200 mTorr or less at the sensor reference port is required. See Appendix A for vacuum pump requirements.

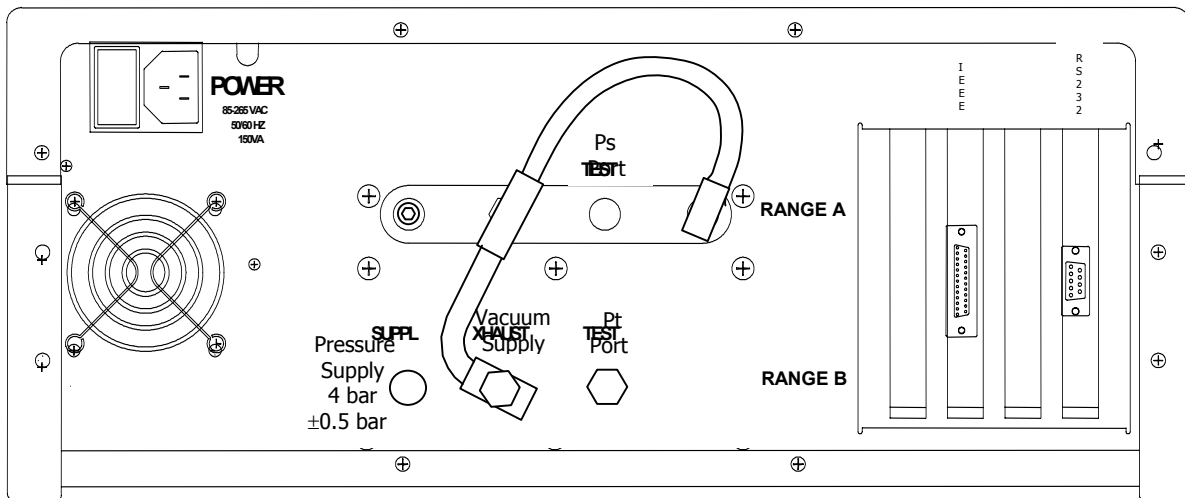

**FIGURE 3-1
MODEL 7750i BACK PANEL**

3.5.5 VACUUM SENSOR

The ADTS has a vacuum sensor connected to the Ps sensor. This sensor is used to zero the GE quartz sensor at a high vacuum.

THIS PAGE INTENTIONALLY LEFT BLANK

SECTION 4.0 LOCAL OPERATION

This section of the manual describes operation of the ADTS using the front panel. The local interface (front panel) consists of a color TFT display, a rotary knob and a set of keys. The display shows the system status and menu options. The keys are grouped according to function.

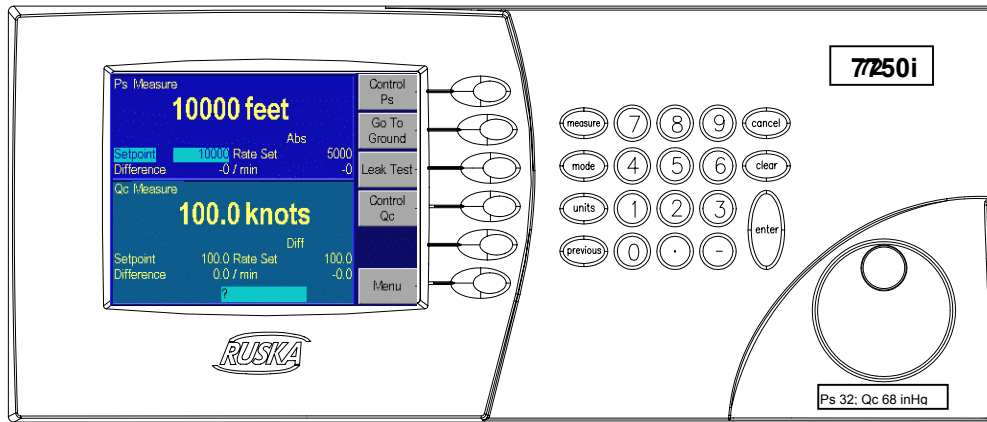

**FIGURE 4-1
MODEL 7750i FRONT PANEL**

Numeric Keypad: This includes the number keys, the decimal point [.] , and the change sign key [-]. The [UNITS] key changes between units of measure, [MODE] held down for 5 seconds changes the language. It also switches to the single display mode and toggles between the two channels in the single channel display mode. [MEASURE] is used to place both channels into measure mode. [CLEAR] key will clear the numeric entry field. The [ENTER] key accepts the entered number or confirms a command.

Function Keys: These are the six keys that run vertically beside the display. The label shown in the display beside each key identifies their function. These functions will change based on which screen you are operating. For ease of communication, throughout the manual we refer to these keys as [F1] through [F6]. We consider the top key to be F1 and the bottom F6.

Rotary knob: The rotary knob select a field for editing and are used for small pressure changes (pressure jog) at the main menu of the single display mode.

CANCEL, PREVIOUS: These keys are used to stop, undo, or exit the current operation. The [CANCEL] key returns all edited fields on the current entry screen to their original values. It also stops the current program sequence or calibration process. The [PREVIOUS] key exits the current menu and returns to the previous menu.

Figure 4-2 is a menu tree showing the relationship between all the menus in the system. Refer to it for selections available under the menu. To move to a lower menu, press the function key with the correct label. To move towards the main menu, press the [PREVIOUS] key.

MENU TREE

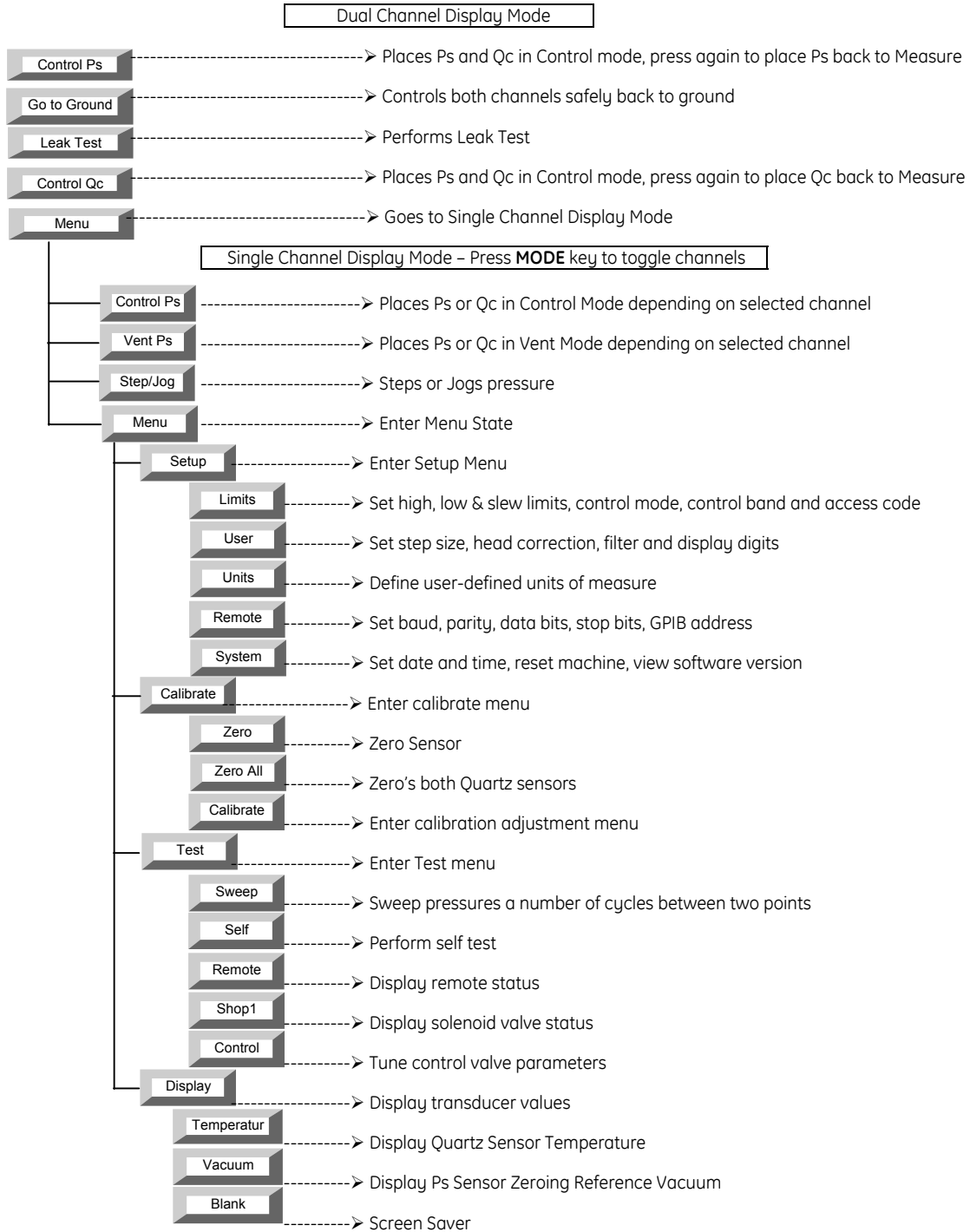
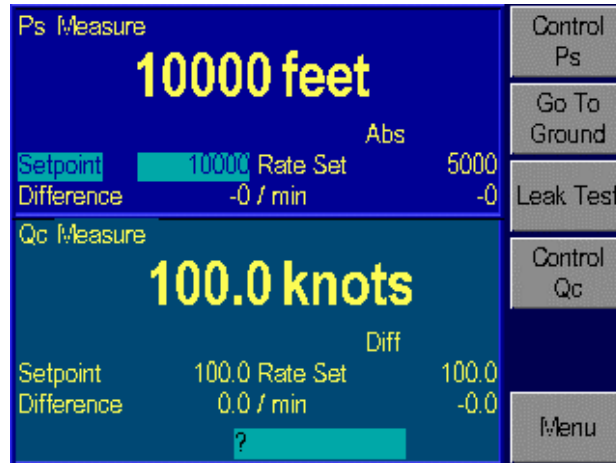

FIGURE 4-2

4.1 DUAL CHANNEL DISPLAY SCREEN

The ADTS should display a screen similar to the one shown below at power up. This is the top of the menu tree. The rotary knob may be used to highlight a set-point to edit. Then enter the new value using the keypad. This will show up in the scratch pad on the lower portion of the screen. Press the [Enter] key and the highlighted value will be updated.



DUAL CHANNEL CONTROL SCREEN

4.1.1 CONTROL Ps and CONTROL Qc

Pressing the Control Ps or Control Qc function key places both channels of the ADTS into the Control Mode. Note, if it is desired to have only one channel in the control mode, press either the Control Ps or Control Qc function key a second time and that channel will be switched back into the measure mode. This will leave only one channel in the control mode. Press [Enter] to confirm the change. You can change the display such that it only displays a single channel. Press the Menu function key to go to the **Ps ONLY CHANNEL** screen. Press the [Mode] key to then toggle between the **Ps ONLY CHANNEL** and the **Qc ONLY CHANNEL** screens.

4.1.2 GO TO GROUND

The Go to Ground [F2] function is used to control the pressure in the system to the atmospheric pressure at ground level. Once at ground level, the ADTS physically vents the test port to atmosphere. This allows the operator to return all of the equipment connected to the ADTS back to atmospheric pressure so they can be safely disconnected from the ADTS.

4.1.3 LEAK TEST

The Leak Test [F3] function is used to perform a leak test on the system. This is a timed leak test that allows the operator to enter a wait time and a run time. The operator would control the system to the desired leak test setpoint. Using the rotary knob, the wait time and the run time can be entered. When initiated, once the wait time has expired, the ADTS would display the current leak rate. This value continuously updates until the run time expires and this displayed value stops updating to document the leak rate over the timed interval.

4.1.4 SINGLE CHANNEL DISPLAY SCREEN

Pressing the [Menu] key from the Main Menu places the unit in a single channel display mode. This mode is generally preferred when operating only a single channel of the ADTS. Press the [Mode] key to then toggle between the **Ps ONLY CHANNEL** and the **Qc ONLY CHANNEL** screens. The ADTS displays the measured pressure in double-sized numbers. Below the pressure reading is the current unit of measure and mode (Gauge, Differential or Absolute). The model 7750i is designed such that all of the commonly used functions are accessible by a direct key on the key pad or from a top level function keys. Less commonly used set-up type functions are accessible through the menu function keys.

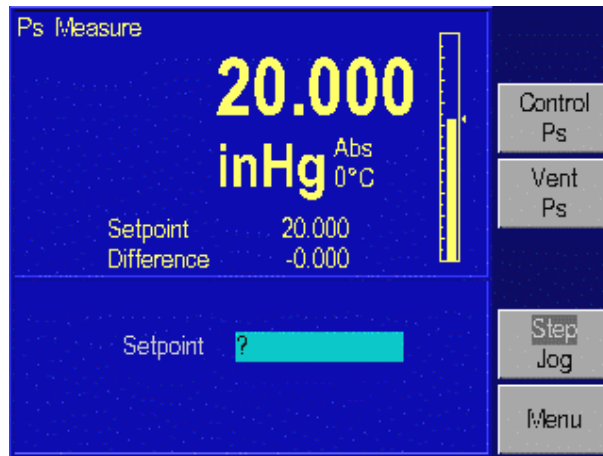

SINGLE CHANNEL DISPLAY: MAIN MENU

4.2 TUTORIAL

To begin the tutorial, first verify that the ADTS is powered-up and that the pneumatic connections have been completed. It is generally easier to first operate the system in the Single Channel Display Screen as opposed to the Dual Screen. Press the [Menu] function key to go to the **Ps Channel** screen. Press the [Mode] key to toggle between the **Ps Channel** and the **Qc Channel** screens. **Ps Channel** is recognizable by the dark blue background color and **Qc Channel** has a lighter background color. Select **Ps Channel** to proceed with the tutorial. The ADTS should display a screen similar to the one shown above. (The right hand side of the display should show the options). At power up, there may be errors relating to the default settings. If an error message is displayed in red at the bottom of the screen, press [F6], then press [PREVIOUS]. If multiple errors exist, you will need to press the [F6] key multiple times to clear all of the errors.

This is the **Ps Channel** Main Menu. The double sized numbers in the top center of the display shows the current measured pressure (20.000 inHg Abs). The upper left corner shows the current mode of the ADTS (MEASURE, CONTROL or VENT). The right side of the screen shows a bar graph displaying the current pressure relative to a user-configurable full-scale value. Below the pressure is the pressure control set-point, below this is the difference between the set-point and the actual value. Below this is a numeric scratchpad for entering a new set-point value. The highlighted label on the right hand side of the screen displays the current assignments of the function keys [F1] through [F6] that are located beside the display.

4.2.1 CHANGING UNITS OF MEASURE

Step 1. Change the pressure units. The units are changed by selecting the UNITS key on the keypad.

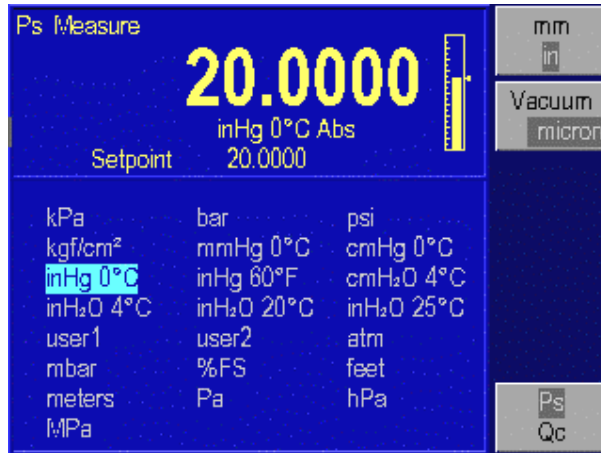

UNITS - MENU

Step 2. Use the rotary knob located to the right of the display to move the highlight bar to the desired unit. Note, the highlighted cursor initially shows the current unit of measure. When the rotary knob is moved, the current unit remains highlighted in a gray color, and the new unit is highlighted in a light blue color.

Step 3. When the unit desired is highlighted, press the [ENTER] key on the far right side of the front panel, under the numeric keypad. The display will return to the MAIN screen with the current units.

Note, you can select a different Unit of Measure for each channel of the ADTS. You will select the unit-of-measure for the Ps channel, and then press the **MODE** key or the **[F6]** Function key, you will toggle to the Qc channel where you can change its unit-of-measure.

The second part of this tutorial uses the ADTS to generate pressure. The pressure supply must be connected and the test port must be connected to a closed volume, in accordance with Section 3.5 of this manual.

Step 4. From the Main Menu, use the numeric keypad to enter the starting pressure. The pressure is entered in the units set in the previous exercise. As the pressure is entered, each digit will be displayed in the numeric scratchpad (the highlighted box in the lower section of the display). If a mistake is made, press the [CLEAR] key (found in the numeric keypad), and the numeric scratchpad will be cleared.



SINGLE CHANNEL DISPLAY: MAIN MENU

- Step 5. When the entry is correct, press the [ENTER] key. The scratchpad will be cleared and the value will appear as the new set-point.
- Step 6. Now that the starting pressure is entered, enter Control mode. Press Control (the [F2] key). The CONTROL label will be highlight, and the message “Press Enter to Confirm” will appear below the scratch pad. Notice that the upper left corner still shows MEASURE. The ADTS stays in Measure mode until the change is confirmed.
- Step 7. Press [ENTER] to confirm the mode change. The upper left corner will change to CONTROL, and the pressure will start moving towards the set-point.
- Step 8. After the pressure is stabilized, assure that the word Step is highlighted in the Step/Jog (the [F5] key). The Step/Jog (the [F5] key) toggles between Step and Jog, to switch between these modes, press the function key 5 [F5]. In addition to using the key-pad to enter a pressure set-point, you can also use the step function. Using the rotary knob, rotate the knob clock-wise to increase the set-point, or counter clock-wise to decrease the controller set-point. The scratchpad will be updated with a new set-point. The step size defaults to 10% of full scale. This step size is user defined and can be changed in the Menu |Menu |Setup |User menu.
- Step 9. Press [ENTER] to accept the new set-point. The ADTS will move to the new set-point.
- Step 10. Press Measure key which is located in the key-pad. The ADTS will change to Measure mode. No confirmation is necessary to leave Control mode.

4.2.2 SELECTING LANGUAGE

The 7750i ADTS can operate in a variety of different languages. To select a different language, press and hold the [MODE] key for 5 seconds. The current language will be highlighted. Use the rotary knob to highlight a new language and hit the [ENTER] key to select that language.

4.3 CONTROLLING PRESSURE

Pressing either the Control Ps or Control Qc function key places both channels of the ADTS into the Control Mode. If it is desired to have only one channel in the control mode, press either the Control Ps or Control Qc function key a second time and that channel will be switched back into the measure mode. This will leave only one channel in the control mode. A pressure set-point should be entered into the ADTS prior to placing the unit into the control mode. This is to assure that the operator is aware of the set-point valve prior to entering into the control mode.

4.3.1 SETTING THE PRESSURE SET-POINT

The pressure set-point is the destination of the pressure control algorithm. It should be set before entering Control mode. The pressure set-point is set to zero at power-up or whenever a pressure error occurs.

1. The pressure set-point can be set from the dual display menu or the Main Menu of the single channel mode. (On the dual channel display mode, use the rotary knob to select which channels set-point is being edited.)
2. Use the numeric keypad to enter the new pressure set-point in the current pressure units.
3. Press [ENTER] to accept the entry or press [CLEAR] to clear the numeric scratchpad.

NOTE: The set point can also be changed using either the Step or the Jog function. Please see Section 4.5.

4.3.2 ENTERING/EXITING CONTROL MODE

1. The Control mode is set from either the dual channel or the single channel display screens. For the Dual channel, press [PREVIOUS] until the Main Menu appears. For the single channel, press the **[MENU]** key and then press the **MODE** key to toggle between the two different channels.
2. In the dual display mode, pressing either the Control Ps or Control Qc function key places both channels of the ADTS into the Control Mode. If it is desired to have only one channel in the control mode, press either the Control Ps or Control Qc function key a second time and that channel will be switched back into the measure mode. This will leave only one channel in the control mode. [ENTER] must be pressed to confirm entry into Control mode. Note that any entry in the numeric scratchpad will also be taken as the new pressure set-point. From the single display screen, press the **Ps Control [F2]** (or Qc Control depending on which channel you are operating) to place the selected channel in control mode. [ENTER] must be pressed to confirm entry into Control mode.
3. Press MEASURE key found in the keypad to exit Control mode. No confirmation is necessary. This will place both channels in the measure mode. Note, in the dual display mode, if both channels are in control mode, you can press either **[F1]** or **[F4]** keys to place only the selected channel into measure mode.

4.4 VENT

The Vent [F3] function is used to control pressure in the selected channel to atmosphere. Once at atmospheric pressure, the ADTS physically vents the test port to atmosphere.

4.5 STEP/JOG

This feature is only available when operating in the single display mode. To place the ADTS in the single display mode from the dual display screen press the **[MENU]** key. In addition to entering the pressure set-point through the key-pad, the pressure set-point can be changed using either the step or the jog functions. The Step function is used primarily when the operator is taking pressure steps in equal pressure increments. The size of the pressure step is user defined. The Jog function is most often used when calibrating mechanical gauges and the operator wishes to change the pressure until the mechanical gauge indicates a cardinal point. The operator can then read the higher resolution ADTS to determine the actual pressure value when the mechanical gauge is indicating a cardinal point. The Step/Jog (the [F5] key) toggles between Step and Jog, to switch between these modes, press the function key 5 [F5].

4.5.1 STEPPING

Assure that the word Step is highlighted in the Step/Jog (the [F5] key). Using the rotary knob, rotate the knob clock-wise to increase the set-point, or counter clock-wise to decrease the controller set-point. The scratchpad will be updated to a new set-point. The step size defaults to 10% of full scale. Press [ENTER] to accept the new set-point.

4.5.1.1 Setting Step Size

From the Main Menu (press [PREVIOUS] until the Main Menu appears), press Menu [F6], Menu [F6], Setup [F2], and then User [F2]. Using the rotary knob, move the cursor to highlight Step Size. Enter the desired step size in the current pressure units and press [ENTER].

4.5.2 JOGGING

Assure that the word Jog is highlighted in the Step/Jog (the [F5] key). From the Single Display Menu, the pressure set-point can be modified by rotating the rotary knob clockwise to increase pressure and counterclockwise to decrease pressure. Each increment or decrement will change the pressure in the least significant digit. Continually rotating the rotary knob, the pressure will continue to change until the rotation is stopped.

4.6 MENU

The menu key is used to access the less commonly accessed configuration type functions. This accesses the Setup, Calibration, Test and Display functions.

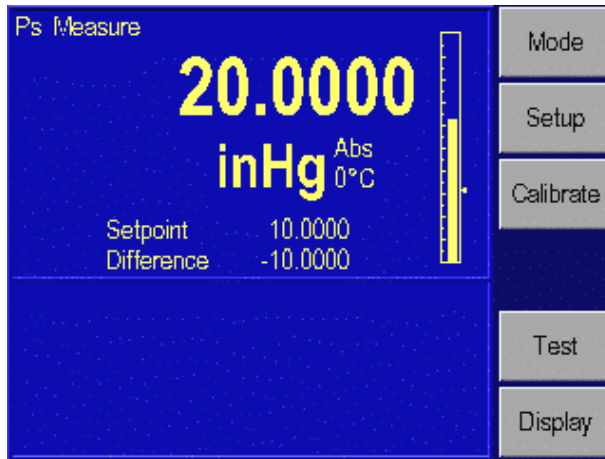

MENU | MENU

4.6.1 MENU | SETUP

Setup is used to configure the system. It includes setting all of the limits, user parameters, user-defined units of measure, remote interface and system setup. On the 7750i, the User and Limits screens are separate for each channel and must be set up independently. The Units, Remote, and System screens are identical in each channel. Any changes made in one channel immediately affects the other channel. Note, units of measure are selected for each independent channel. The Setup Units is used to set up the user defined units of measure.

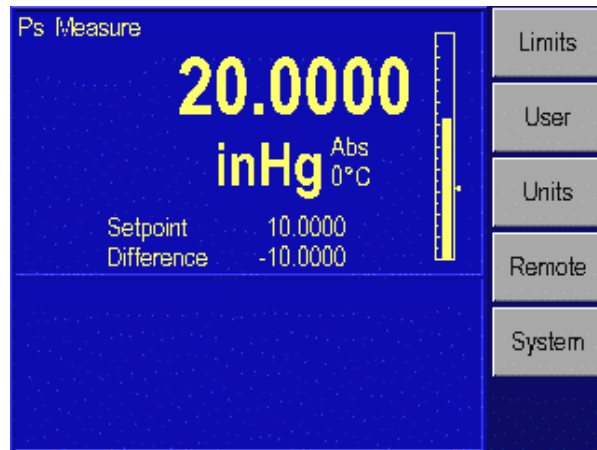

MENU | MENU | SETUP

4.6.1.1 Menu | Setup - Limits

The Menu | Menu | Setup | Limits menu is used to setup all of the limits in the system. The pressure limits can be used to protect the device-under-test (DUT) from overpressure. All limits are defined separately for each channel. Press the **[Mode]** key to switch between two pressure channels. The Access code is common and is used for both channels.



MENU | MENU | SETUP | LIMITS

4.6.1.1.1 High Limit – User defined Maximum pressure limit. This is often set just over the full-scale pressure of the device under test (DUT) in order to protect the DUT. The ADTS will then prevent the pressure from exceeding the high limit. Limits can be set in both engineering and aeronautical units of measure. If the user enters a value greater than the user defined limit, the unit will not accept the value and it will generate an error code informing the user that they have entered a set-point that is greater than the high pressure limit. In control mode, if for any reason the pressure exceeds the user defined limit, it will change into the measure mode and again display an error message to the operator informing them of the error that occurred.

This value can be edited using the rotary knob to highlight the High Limit. Then enter the new value using the keypad. This will show up in the scratch pad on the lower portion of the screen. Press the Enter key and the value for the high limit will be updated to the value that was typed into the scratchpad.

4.6.1.1.2 Low Limit – User defined Minimum pressure limit. This is the same as the high limit except it is to protect the DUT from low pressure limits.

4.6.1.1.3 Auto Vent – User defined maximum pressure that the ADTS can reach prior to venting the test port to atmosphere. The auto vent controls the pressure to atmosphere at then vents the pressure to atmosphere.

4.6.1.1.4 Control Band – There are two common pressure control approaches that are available with the GE 7750i ADTS. One of the most common control styles is an Active controller where the controller remains operative and holds the pressure at a commanded set-point. This allows the system to hold the pressure at a set-point within the control stability specification (See Appendix A). In addition to possible leaks in a system, following a pressure step, the pressure in the system changes due to temperature effects. When operating an Active control system, the controller continuously monitors any pressure variances in the system and compensates for these effects to hold the pressure at the set-point. The benefit of the Active control is that it can maintain the pressure at the commanded set-point even when there are slight leaks in the system or the system is not thermally stable.

The second approach is to control the pressure in the system to a set-point and then to shut-off the Active controller. We describe this as a Passive control mode. Following a pressure step and the controller becomes passive, the pressure will continue to change in the system due to thermal effects. However these thermal effects will stabilize over time. Once the system has thermally stabilized, pressure measurements can be made in the system without any “pressure noise” injected into the system as a result of having an Active controller in the system. The result would be that the controller would not add any additional uncertainty to the pressure measurement since it would be inactive during the measurement process. For this method, pressure will not be at a cardinal set-point.

When the Control Off Band and Control On Band are set to zero, the ADTS operates in the Active control mode. Setting a Control On and Off Band, places the ADTS in the Passive control mode.

The Control On and Off Band provides a tolerance around the pressure set-point in the current unit of measurement. The Controller will control the pressure to the commanded set-point. Once the actual pressure is within the user defined +/- Control Off Band tolerance, the controller will shut off. The pressure will remain at this level, only changing by the thermal influences or leaks in the system. The controller will remain off until it reaches the +/- Control On Band limit. The controller will then re-activate and control the pressure back to the Control Off Band tolerance. This mode of operation removes any added uncertainty in the measurement system due to the controller since the controller is Passive during the high accuracy pressure measurements.

As an example, the Ps channel could be set-up with the Control Off Band at 0.000 inHg and the Control On Band set to 0.005 inHg. This would place the ADTS in a Passive control mode. If the ADTS was placed into the control mode with a pressure set-point of 20 inHg, it would control up to the 20 inHg value. Once it reached a pressure of 20.000 inHg, the active control would turn off. Due to the thermal effects caused by pressurizing the system, the pressure will start changing in the system. Once the pressure reached either 19.995 or 20.005 inHg the active controller would automatically turn on and control the pressure back to 20.000 inHg and then turn off. After a few cycles, the system will thermally stabilize and the pressure will hold between the Control On and Control Off Bands.

4.6.1.1.5 ARINC 565 Operating Limits – The ADTS can be set to the ARINC 565 operating limits. When this is selected as YES, the ADTS ignores the user defined minimum and maximum airspeed and altitude limits and enable the ARINC limits. These limits are defined in Figure 4-3.

4.6.1.1.6 Supply Correction – If the supply pressure is set at a value less than the value recommended in section A.2 of Appendix A, then the control performance may be effected. In this case, the Supply Correction can be set to yes, and the ADTS will adjust its internal control parameters to compensate for the lack of supply pressure. For best performance, it is recommended to supply the ADTS with the full recommended supply pressure and to have the Supply Correction set to no.

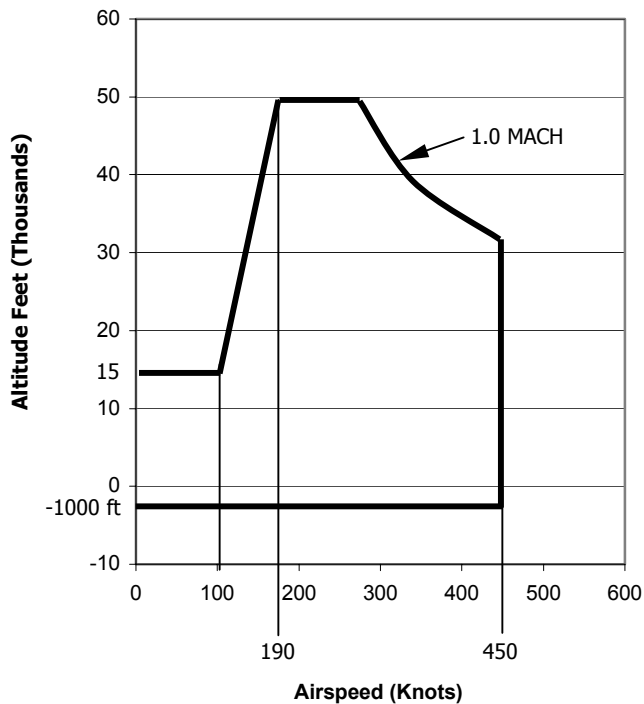

FIGURE 4-3

4.6.1.1.7 Slew Rate – User defined maximum pressure rate of change. The ADTS allows the operator to set the rate for both channels of the ADTS.

4.6.1.1.8 Slew Limit – The slew limit is used by the system to assure that the slew rate is not exceeded. If the slew rate is exceeded, the ADTS will change from the control mode to the measure mode and it will generate an error message to the operator.

4.6.1.1.9 Negative Qc Limit – The Negative Qc limit is the maximum allowable negative differential pressure (and negative airspeed) allowed. When in control mode and this limit is exceeded, the ADTS will change from the control mode to the measure mode and it will generate an error message to the operator. This limit only exist in the Qc limit screen. Press **[MODE]** key to toggle between the Ps and the Qc channels.

4.6.1.1.10 Access – The test access password allows the user to protect access to ADTS configuration and programs. If the test access password is set to any number other than zero (factory default), it is *required* before the user is allowed to change the limits, control parameters or programs. The access key is only shown on the Ps channel. Press **[MODE]** key to toggle between the Ps and the Qc channels.

IMPORTANT: It is recommended that the access password be recorded and filed in a secure location.

4.6.1.2 Menu | Setup – User

The Menu | Menu | Setup | User menu is used to setup all of the user specific configurations. This includes setting the control step size, range of bar-graph, pressure gas head, display

pressure filter, display resolution digits, and audible key click. The step size, bar-graph max, ready tolerance and gas head are defined separately for each channel. All other entries are common for both channels. Press **[MODE]** key to toggle between the Ps and the Qc channels.



MENU | MENU | SETUP | USER

4.6.1.2.1 Step Size - In addition to entering the pressure set-point by the key-pad, the pressure set-point can be changed using the step function. The step function is used primarily when the operator is taking pressure steps in equal pressure increments. The size of the pressure step is user defined. From the Main Menu (press [PREVIOUS] until the Main Menu appears), press Menu [F6], Menu [F6], Setup [F2], and then User [F2]. Using the rotary knob, move the cursor to highlight Step Size. Enter the desired step size in the current pressure units and press [ENTER].

4.6.1.2.2 Bar Graph Maximum - The bar graph on the Main Menu screen can be scaled to match the device under test by setting the full scale value of the bar graph.

4.6.1.2.3 Ready Tolerance - A Ready indication is generated when in control mode and the measured pressure is reading within this ready tolerance value. When running an internal program, the ready indicator is shown when the measured pressure is within the tolerance stored in the program. It is recommended that the Ready tolerance be set to a value greater than the Control Stability Specification defined in Appendix A.

4.6.1.2.4 Gas Head Pressure Correction - The term “head height” refers to the vertical distance between the sensing element in the device under test and the ADTS’s pressure reference plane. Once the user inputs the head height and selects air or nitrogen, the ADTS automatically corrects for head pressure.

1. The Pressure Reference Line on the ADTS is defined as the bottom of the color display where the display and the front panel join. This provides the *reference plane* against which the device under test (DUT) pressure is measured.
2. Determine the vertical distance between the ADTS Pressure Reference Line and the reference plane of the device under test.
3. Press the Unit key found in the keypad and press in/mm [F1] to select either inches (in) or millimeters (mm) for the head height entry.

4. The head height is set from the Menu | Menu |Setup | User. From the Main Menu (press [PREVIOUS] until the Main Menu appears), press Menu [F6], press Menu [F6], then Setup [F2], and then User [F2].
5. Press Medium [F3] to select either “Air” or “Nitrogen.” The selected units will be highlighted.
6. Press Position [F4] to select if the position of the Device Under Test is either “Above” or “Below” the 7750i. The selected units will be highlighted and appear in the Gas Head description.
7. Use the rotary knob to highlight the label “Gas Head.”
8. Use the numeric keypad to enter the height in the selected unit.
9. Press [ENTER] to accept the entry.

4.6.1.2.5 Atmosphere – The nominal barometric pressure value for the location that the ADTS is utilized should be entered for atmosphere. This number is used to calculate the density of the test port pressure medium and to correct for head pressure variances between the reference port of the ADTS and the DUT.

4.6.1.2.6 Pressure Filter – is used to adjust the degree to which the front display pressure value is filtered. A value of four (4), is the default value. As the value increases, the filtering level increases, however, the display update rate reduces. Typical filter values would range between 1 to 10. For pressure sensors with full scale ranges of 1 psi (7 kPa) or less, a filter value up to 30 is typically recommended.

4.6.1.2.7 Changing the Number of Decimals – Each unit has a default number of decimal places used for pressure display. This may be adjusted up or down by one decimal place.

1. The decimal digits are set from the Menu | Menu |Setup | User. From the Main Menu (press [PREVIOUS] until the Main Menu appears), press Menu [F6], Menu [F6], then Setup [F2], and then User [F2]. Press the [MODE] key to toggle between the Ps and the Qc channels.
2. Turn the rotary knob until the label “Display digits” is highlighted.
3. Turn the rotary knob further until the desired number of digits from the default resolution is highlighted (-1, 0, +1), and then press the [ENTER] key to select.

4.6.1.2.8 Key Click – The ADTS can be configured to emit a “clicking” sound each time a key is pressed.

1. The key “click” is set from the Menu | Menu |Setup | User. From the Main Menu (press [PREVIOUS] until the Main Menu appears), press Menu [F6], Menu [F6], then Setup [F2], and then User [F2].
2. Turn the rotary knob to highlight “Key click” and then highlight either on or off.
3. Press the [ENTER] key to select.

4.6.1.3 Menu | Setup – Units

In addition to the standard units of measure provided by the ADTS, four user-defined units are available. To create a user-defined unit, the user enters a *name* that is one to ten characters long and a *conversion factor* that is a multiple of kiloPascals (kPa).

For example, using the information from table 2-1, the conversion factor for millitorr or one micron of mercury at 0 °C is calculated as follows.

$$mTorr = kPa \times \frac{1000mTorr}{1Torr} \times \frac{1Torr}{1mmHg0^{\circ}C} \times \frac{1mmHg0^{\circ}}{0.0193377psi} \times \frac{0.1450377psi}{1kPa}$$

thus the conversion factor simplifies to mTorr = kPa × 7500.6180

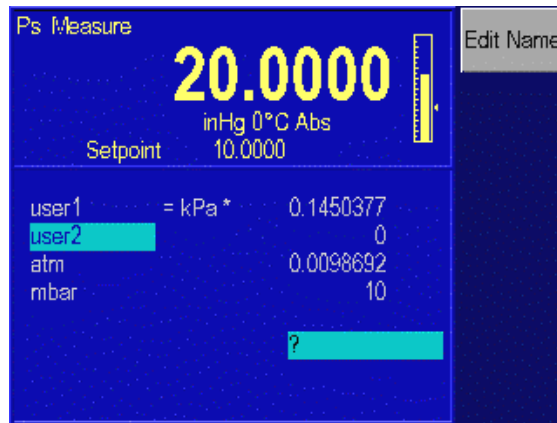

MENU | MENU | SETUP | UNITS

1. The pressure units are defined from the Menu | Menu| Setup | Units. From the Main Menu (press [PREVIOUS] until the Main Menu appears), press Menu [F6], Menu [F6], then Setup [F2], then Units [F3].
2. Use the rotary knob to highlight the desired user-defined unit, and then select the Edit Name [F1] function key.
3. The following sequence is used to change the name of the selected unit.

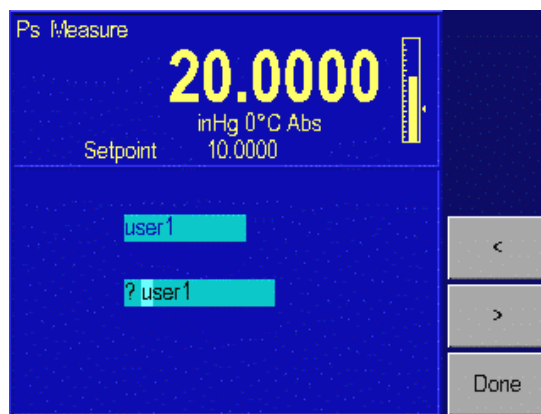

MENU | MENU | SETUP | UNITS | EDIT NAME

- a. Use the < [F4] or > [F5] key to highlight the desired character in the matrix.
 - b. Use the rotary knob to change the character.
 - c. Repeat steps a and b until the desired name is entered. Press the Clear key to start over.
 - d. Press the Done [F6] key when the name change is completed.
4. Use the rotary knob to highlight the desired user-defined unit that has just been renamed.
 5. Use the numeric keypad to enter the conversion factor and press [ENTER] to accept.
 6. Press [PREVIOUS] three times to return to the Main Menu. The new unit definition may now be selected using the units key.

4.6.1.4 Menu | Setup – Remote

The Menu | Setup | Remote screen is where the remote communication interface is set-up.

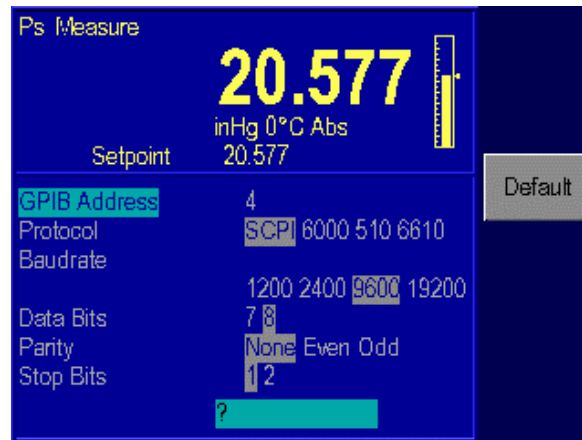

MENU | MENU | SETUP | REMOTE

4.6.1.4.1 GPIB Address – Sets the IEEE-488 interface address.

4.6.1.4.2 Protocol – The Protocol defines which protocol should be used by the remote interface. The options are Standard Communication for Programmable Instruments (SCPI) which is the only interface available for the 7750i.

4.6.1.4.3 Serial Interface Set-Up – The operator can set-up the Baud Rate, Data Bits, Parity, and Stop Bits for the Serial Interface.

4.6.1.5 Menu | Setup – System

The System Menu identifies the Software release version that is being operated in the ADTS. It also stores and allows the operator to edit the Date and Time.

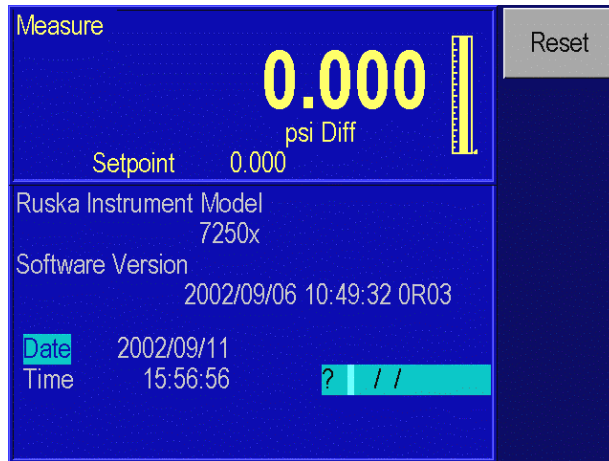

MENU | MENU | SETUP | SYSTEM

4.6.1.5.1 Date/Time

The ADTS's system clock is continuously updated. If the date or time requires editing, the following applies;

1. The date and time are set from the Menu | Menu | Setup | System. From the Main Menu (press [PREVIOUS] until the Main Menu appears), press Menu [F6], Menu [F6], then Setup [F2], and then System [F5].
2. To set the system date, turn the rotary knob until Date is highlighted. Use the numeric keypad to enter the current four-digit year, month, and day (*yyyymmdd*). All digits must be entered. Press [ENTER] to accept.
3. To set the system time, turn the rotary knob until Time is highlighted. Use the numeric keypad to enter the current hour, minute, and second (*hhmmss*). All digits must be entered. Press [ENTER] to accept.

4.6.1.5.2 Reset

The Reset [F1] command is used to re-boot the ADTS.

1. To reset the system, from the Main Menu (press [PREVIOUS] until the Main Menu appears), press Menu [F6], Menu [F6], then Setup [F2], then System [F5], and then Reset [F1].

4.6.2 MENU | CALIBRATE

The Menu | Calibrate command is used to perform the calibrations on all of the sensors utilized by the ADTS. The 7750i can be completely calibrated using the front panel interface. It does not require any external computer or software in order to perform a successful calibration. It also has the capability of being calibrated remotely through either the RS232 or IEEE-488 interface. The 7750i will guide the operator through a menu driven calibration procedure identifying the pressures that should be supplied by a standard. Following the calibration procedure, the 7750i calculates and saves its own coefficients. The calibration coefficients are date stamped so the user can easily identify the last time the instrument went through a full calibration, when the coefficients were last edited or when the ADTS was re-zeroed.

The calibration section in the ADTS can be password protected to prevent any unauthorized entry into the calibration section of the system. Please refer to the Maintenance Section (Section 6.0) of the manual for more detailed information regarding the calibration of the ADTS. The calibration menu is identical in both channels. Press the Sensor function key to select the correct sensor from either channel.

4.6.2.1 Calibration Password

The calibration password allows the user to protect access to ADTS calibration constants and the calibration procedure. If the calibration password is set to any number other than zero, it is *required* before the user is allowed to calibrate the ADTS or manually change the calibration constants.

IMPORTANT: It is recommended that the access password be recorded and filed in a secure location.

1. The calibration password is set from the Calibration Menu. From the Main Menu (press [PREVIOUS] until the Main Menu appears), press Menu [F6], Menu [F6], then Calibrate [F3].
2. Press the Access [F4] key. If there is a password in the system other than 0, then you must enter the current valid password into the 7750i before it will allow you to modify the password.
3. Use the numeric keypad to enter the new calibration password. Setting the calibration password to zero allows free access to ADTS calibration and constants. Press [ENTER].
4. Press Yes [F4] to acknowledge changing the calibration password. Press No [F5] to reject changing the calibration password.

4.6.2.2 Zeroing

GE recommends that the ADTS be zeroed once a day to maintain optimal performance. The zero drift specification is defined in Appendix A under General Specifications. Refer to Section 6.4.5 for the zeroing procedure. On the differential Qc sensor, the zeroing procedure automatically ties both test and reference ports of the quartz sensor together and performs the zeroing routine.

On the permanent absolute Ps sensor, a high capacity vacuum pump is required to zero the instrument. A vacuum gauge sensor is installed internally to the ADTS very near to the GE quartz sensor. When initiating the zeroing command in the ADTS, it will cycle the internal valves allowing the external vacuum pump to pull a hard vacuum on the quartz sensor. It is recommended that the sensor be pulled down to a vacuum of less than 200 mtorr in order to obtain a proper zero. Note, for the highest measurement performance, it is recommended to zero the 7750i at a vacuum level of 100 mtorr or less. The ADTS can be zeroed at higher vacuum levels, however, the uncertainty of vacuum sensors tend to increase at higher vacuum levels, therefore, the uncertainty in the ADTS would also increase if zeroed at higher vacuum levels. It is also important that the vacuum level be stable to a least 5 mtorr per minute. Once the vacuum level is stable, the user initiates the zeroing procedure. Please refer to the Maintenance Section (Section 6.0) of the manual for more detailed information regarding the zeroing procedure of the ADTS.

4.6.3 MENU | TEST

The Menu | Test section of the system is used to perform a number of the diagnostic and tuning functions that are available with the 7750i. The Sweep and Control test operate on the current selected channel. The other screens are independent of the selected channel.



MENU | MENU | TEST

4.6.3.1 Menu | Test – Sweep Test

The sweep function can be used to automatically exercise the elastic sensing element of the device under test prior to performing a calibration. For the ADTS to perform the sweep test, input the high and low set-point pressures, the pressure control tolerance, the dwell time at set-point, and the number of cycles to perform.

1. Ensure that the units, limits, and control parameters are set to their desired values.
2. The sweep test is entered from the Sweep Test Menu. From the Main Menu (press [PREVIOUS] until the Main Menu appears), press Menu [F6], Menu [F6], then Test [F5], and then Sweep [F2].
3. Enter the high and low pressure points, the control tolerance, dwell time, and the number of cycles.

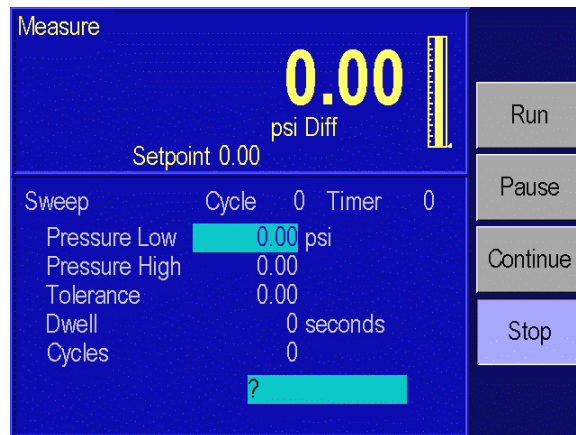

MENU | MENU | TEST | SWEEP

4. Press Run [F2] to initiate the test.

5. To pause the program, press Pause [F3]. Pause will now be highlighted and the ADTS will continue controlling to the current set-point. The ADTS will maintain control of the current set-point until further instructions from the user. Press Continue [F4] to resume the program.
6. To stop the program, press Stop [F5]. The program will stop running but the ADTS will continue controlling to the current set-point.

4.6.3.2 Menu | Test – Self Test

The ADTS can perform electrical and pneumatic self test to assist in trouble shooting potential problems. Please refer to the Maintenance – Section 6.0 for more details.

NOTE: In order to perform a pneumatic self test, the supply port must be connected to a properly set supply pressure and the test port not open to atmosphere. For absolute units, a vacuum supply must also be connected to the exhaust port.

4.6.3.3 Menu | Test – Remote Test

The Menu | Menu | Test | Remote section of the system is used to perform a number of the diagnostic functions on the remote interface. It can be used to display the transmitted and received messages that are sent across the interface. This can be a powerful tool to assist in identifying the source of communication problems.

The Menu | Menu| Test | Remote menu displays information from the IEEE-488 interface. Pressing the Serial 1 [F2] or Serial 2 [F3] keys will display information from the serial ports.

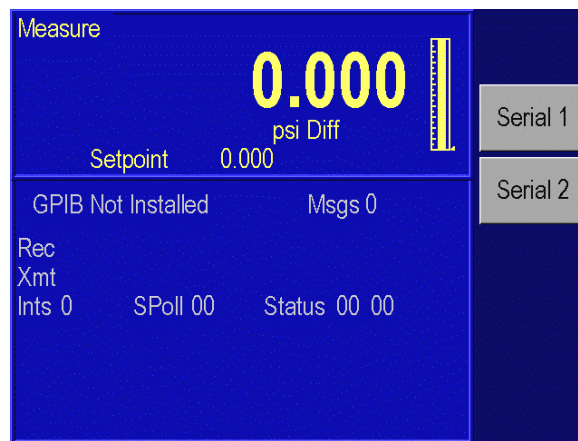

MENU | MENU | TEST | REMOTE – GPIB

4.6.3.4 Menu | Test – Shop1

The Menu | Menu | Test | Shop1 menu of the system is used to display the current status of the various valve positions in the system. This menu is primarily used for diagnostics and will be discussed further in the Maintenance Section 6.0.

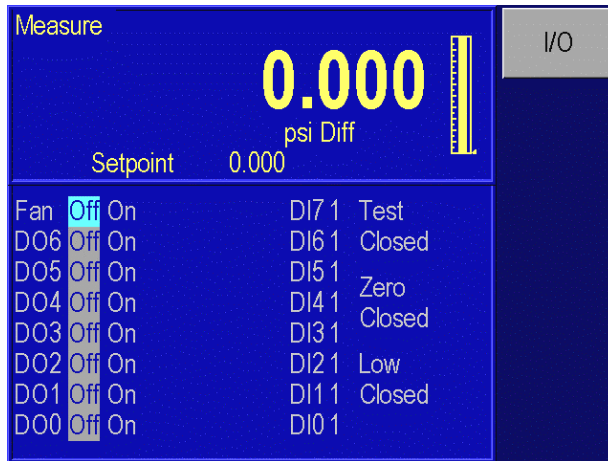

MENU | MENU | TEST | SHOP1

4.6.3.5 Menu | Test – Control

The Menu | Menu | Test | Control menu of the system is used to tune the controller. On new instruments, the controller is tuned at the factory and therefore, the user should not need to access or make any adjustments to the controller using this menu. This menu is user accessible in order to provide a means to set-up the controller when control valves are replaced or to perform maintenance on the controller. This menu is primarily used for diagnostics and repair and will be discussed further in the Maintenance Section 6.0.



MENU | MENU | TEST | CONTROLLER

4.6.4 MENU | DISPLAY

The Menu | Menu | Display is used to conveniently monitor most of the sensor output parameters. It is primarily used for troubleshooting. This display screen shows all available sensor readings from both channels.

4746853	20.577 inHg	A	O	Temp.
71077	100.0 knots	B	O	
2373426	20.570 inHg	A	f:Measure	Vacuum
17769	93.8 knots	B	f:Measure	Blank

MENU | MENU | DISPLAY

4.6.4.1 Menu | Display - Temperature

This displays the current temperature of each sensor and the oven control duty cycle.

4.6.4.2 Menu | Display - Vacuum

This displays the current reading from the vacuum sensor that is used to zero the Ps sensor.

When railed to a high value, it indicates 350 mtorr. When the vacuum level present in the Ps sensor is less than 350 mtorr, this sensor indicates the actual vacuum level.

4.6.4.3 Menu | Display - Blank

This is used as a screen saver in the 7750i.

SECTION 5.0 REMOTE OPERATION

5.1 CAPABILITIES

The ADTS can be operated remotely by a computer. Two interfaces are supported: IEEE-488 and RS-232. Both interfaces support SCPI (Standard Commands for Programmable Instruments). The IEEE-488 interface additionally supports emulation of a Ruska Model 6610 ADTS. The IEEE-488 interface conforms to the following standards:

ANSI/IEEE Std 488.1-1987 IEEE Standard Digital Interface for Programmable Instrumentation

ANSI/IEEE Std 488.2-1987 IEEE Standard Codes, Formats, Protocols, and Common Commands

SCPI 1991.0 Standard Commands for Programmable Instruments

5.1.1 IEEE-488

The following identification codes define the interface capabilities of the ADTS. Identification codes are described in the IEEE-488 standard.

SH1	Source Handshake, Complete Capability
AH1	Acceptor Handshake, Complete Capability
T5	Talker
L3	Listener
SR1	Service Request, Complete Capability
RL1	Remote-Local, Complete Capability
PP0	Parallel Poll, No Capability
DC1	Device Clear, Complete Capability
DT0	Device Trigger, No Capability
C0	Controller, No Capability

The IEEE-488 interface is installed next to the processor board. The interface is identified by the IEEE-488 standard connector on the back panel of the unit.

NOTE: Do not change any jumpers or switch settings on the IEEE-488 interface board. The IEEE-488 address is set by the MENU/SETUP/REMOTE screen.

5.1.2 RS-232

The RS-232 interface supports standard serial operation from a computer to a single ADTS. RS-232 supports the IEEE-488.2 and SCPI commands. The ADTS allows the following port setups:

Baud Rate:	1200, 2400, 9600, or 19200
Data Bits:	7 or 8
Parity:	Even, Odd, or None
Stop Bits	1 or 2
Handshaking	XON/XOFF

The RS-232 connection is a DB-9P connector found on the back panel of the ADTS. It is located on the processor board. The following pins are used; all other pins are reserved.

Pin #	Direction	Signal
2	In	RXD Receive Data
3	Out	TXD Transmit Data
5	—	GND Ground
7	Out	RTS Request to Send

5.2 REMOTE/LOCAL OPERATION

In Local mode, the ADTS is operated manually through the front panel. Section 4.0 covers local operation. The ADTS always powers up in the Local mode. In Remote mode, the ADTS is operated by a computer connected to an interface. Most functions that can be performed in Local mode can also be performed remotely.

Remote mode does not automatically disable local operation. The remote interface may be active while local operations are being done. In cases where full remote control is required, the following methods may be used.

1. Issue a Local Lockout (LLO) interface message via the IEEE-488 interface. The ADTS will disable the local keyboard until the Go To Local (GTL) interface message is received or the REN (Remote Enable) line is unasserted. This method cannot be used on the serial interface.
2. Issue the SCPI command "SYSTEM:KLOCK ON" to lock the local keyboard. The ADTS will disable the local keyboard until the command "SYSTEM:KLOCK OFF" is received.
3. Issue the SCPI command "DISPLAY:ENABLE OFF" or "DISPLAY:TEXT <string>." These commands will disable the local display in addition to locking the keyboard. The command "DISPLAY:ENABLE ON" will restore the local display and keyboard operation.

Local operation may also be restored by turning the ADTS off and back on.

5.3 CONFIGURATION

The remote interface must be configured before it is connected. The remote interface is configured using the local interface. The parameters needed vary with the interface used.

IEEE-488	Address, Protocol
RS-232	Baud Rate, Data Bits, Parity, Stop Bits

To configure the remote interface:

1. The remote interface is configured from the Setup | Remote | Menu. From the Main Menu (press [PREVIOUS] until the Main Menu appears), press Menu [F6], then Setup [F2], and finally Remote [F4].
2. Use the rotary knob to highlight the desired parameter.
3. Use the numeric keypad to enter the address; use the rotary knob to change the other parameters. The [ENTER] key must be pressed after entering the address.
4. Repeat steps 2 and 3 to set all parameters needed.

5.4 DEVICE MESSAGES

5.4.1 SCPI COMMAND FORMAT

SCPI mnemonics have two forms: long and short. The short form is all in capital letters. The long form is the entire mnemonic. Commands may use either the short form or the entire long form. No other forms are accepted. SCPI ignores case: uppercase and lowercase are equivalent.

A SCPI command is made by following the command tree as presented in the command summary. Each level adds a mnemonic to the command separated by colons (:). Mnemonics enclosed in square brackets are optional and may be omitted.

Some mnemonics are followed by an optional numeric suffix. If omitted, the suffix defaults to 1.

Multiple commands may be placed in a single message separated by semicolons (;). Each command starts at the same level of tree where the last command stopped, unless the command starts with a colon. The first command in a message and any commands starting with a colon start at the root of the command tree. IEEE 488.2 commands may occur between SCPI commands without affecting the tree level.

Command parameters are separated from the command name by one or more spaces. Multiple parameters are separated by commas (,). SCPI accepts numeric parameters with optional sign, decimal point, and exponent. OFF is equivalent to zero and ON is equivalent to one. Floating point numbers are rounded to the nearest integer for commands accepting integer values only.

A message is terminated by a line feed (hexadecimal 0A). Carriage returns, tabs, and other control characters are ignored.

5.4.2 SCPI RESPONSE FORMAT

Most values can be queried by appending a question mark (?) to a command and not specifying any parameters. Commands ending with a question mark (?) in the command summary cannot be set only queried. Multiple values from a single command are separated by commas. Responses from different commands in the same message are separated by semicolons (;). The response message is terminated by a line feed (hexadecimal 0A).

Integer responses are returned as one or more digits. Boolean values (ON and OFF values) are always returned as numbers, with zero for OFF and one for ON. Floating point values are returned in the format "+d.ddddddddE+dd."

5.4.3 ANSI/IEEE 488.2-1987 COMMAND SUMMARY

*CLS	Clear Status
*ESE?	Event Status Enable Query
*ESE <number>	Event Status Enable
*ESR?	Event Status Register
*IDN?	Identification
*OPC?	Operation Complete Query (Returns 1)
*OPC	Operation Complete
*RST	Reset
*SRE?	Service Request Enable Query
*SRE <number>	Service Request Enable
*STB?	Status Byte Query
*TST?	Self-Test Query
*WAI	Wait (No operation)

5.4.4 SCPI COMMAND SUMMARY

The current value associated with a SCPI command may be read by appending a question mark to the command. For example CALC:LIM:UPP? will return the current upper pressure limit.

MEASure

[:PRESSure]?	Ps Channel Pressure
[:PRESSure]11?	Qc Channel Pressure
[:PRESSure]4?	Ps Control Sensor
[:PRESSure]14?	Qc Control Sensor
[:PRESSure]? ALT	Altitude**
[:PRESSure]? CAS	Airspeed**
[:PRESSure]? MACH	Mach
[:PRESSure]? PS	Ps Pressure
[:PRESSure]? QC	Qc Pressure
[:PRESSure]? PT	Pt Pressure
:RATE? ALT	Altitude instant rate**
:RATE? CAS	Airspeed instant rate**
:RATE? MACH	Mach instant rate
:RATE? PS	Ps instant rate
:RATE? QC	Qc instant rate
:RATE? PT	Pt instant rate
:TEMPerature2?	Ps Sensor Temperature
:TEMPerature12?	Qc Sensor Temperature
:TRATE? ALT	Altitude timed rate**
:TRATE? CAS	Airspeed timed rate**
:TRATE? MACH	Mach timed rate
:TRATE? PS	Ps timed rate
:TRATE? QC	Qc timed rate
:TRATE? PT	Pt timed rate
:VACuum?	Ps Vacuum
:VACuum11?	Qc Vacuum

CALCulate

[:PRESSure]

:TARE		
:VALue <number>		Tare Ps Sensor
:STATe ON OFF		Tare State
:LIMit		
:LOWer <number>		Ps low pressure limit
:SLEW <number>		Ps slew rate limit
:UPPer <number>		Ps high pressure limit
:VENT <number>		Ps auto-vent limit
:PRESSure11		
:LIMit		
:LOWer <number>		Qc low pressure limit
:SLEW <number>		Qc slew rate limit
:UPPer <number>		Qc high pressure limit
:VENT <number>		Qc auto-vent limit
:MAXimum		
:PRESSure ALT,<number>		Maximum Altitude limit**
:PRESSure CAS,<number>		Maximum Airspeed limit**
:PRESSure MACH,<number>		Maximum Mach limit
:PRESSure PS,<number>		Maximum Ps pressure limit
:PRESSure QC,<number>		Maximum Qc pressure limit
:PRESSure PT,<number>		Maximum Pt pressure limit
:RATE ALT,<number>		Maximum Altitude rate limit**
:RATE CAS,<number>		Maximum Airspeed rate limit**
:RATE MACH,<number>		Maximum Mach rate limit
:RATE PS,<number>		Maximum Ps Pressure rate limit
:RATE QC,<number>		Maximum Qc Pressure rate limit
:RATE PT,<number>		Maximum Pt Pressure rate limit
:MINimum		
:PRESSure ALT,<number>		Minimum Altitude limit**
:PRESSure CAS,<number>		Minimum Airspeed limit**
:PRESSure MACH,<number>		Minimum Mach limit
:PRESSure PS,<number>		Minimum Ps pressure limit
:PRESSure QC,<number>		Minimum Qc pressure limit
:PRESSure PT,<number>		Minimum Pt pressure limit
CALibration		
:MODE?		Calibration enabled?
:MODE <number>		Request calibration mode (access code)
:DRY		
:ABORt		Ps Abort dry mode
:INITiate		Ps Initiate dry mode
:PRESSure		
:ZERO		
:ALL		
:VACuum <number>		Set maximum vacuum (UNIT:VAC)
:INITiate		Start Ps and Qc zero
:STOP		abort zero calibration
:WAIT <minutes>,<seconds>		Set minimum zero wait time
:PRESSure		
:VALue<n> <number>		perform Ps calibration point
:DATA		
:POINTs?		number of Ps calibration constants
:VALue<n>?		label,value (C0,0.123)

:VALue<n> <number>	Set calibration constant
:CALibration	
:VALue<n>?	Ps nominal calibration point
:POINts?	Ps number of calibration points
:DATE?	Ps last calibration date
:TIME?	Ps last calibration time
:ZERO	
:DATE?	Ps last zero date
:TIME?	Ps last zero time
:VALue <number>	Ps sets vacuum value (UNIT:VAC)
:VACuum <number>	Ps set maximum vacuum (UNIT:VAC)
:INITiate	Ps enter zero mode
:INITiate?	Ps status for cal, press, temp, ref
:RUN	Ps start zero calibration
:STOP	abort zero calibration
:WAIT <minutes>,<seconds>	Set minimum zero wait time
:PRESSure11	
:VALue<n> <number>	perform Qc calibration point
:DATA	
:POINts?	number of Qc calibration constants
:VALue<n>?	label,value (C0,0.123)
:VALue<n> <number>	Set calibration constant
:CALibration	
:VALue<n>?	Qc nominal calibration point
:POINts?	Qc number of calibration points
:DATE?	Qc last calibration date
:TIME?	Qc last calibration time
:ZERO	
:DATE?	Qc last zero date
:TIME?	Qc last zero time
:INITiate	Qc enter zero mode
:INITiate?	Qc status for cal, press, temp, ref
:RUN	Qc start zero calibration
:STOP	abort zero calibration
PRESsure4	Ps Control Sensor
:VALue<n> <number>	perform calibration point
:DATA	
:POINts?	number of calibration constants
:VALue<n>?	label,value (C0,0.123)
:VALue<n> <number>	set calibration constant
:CALibration	
:VALue<n>?	nominal calibration point
:POINts?	number of calibration points
:ZERO <number>	Zero sensor
PRESsure14	Qc Control Sensor
<i>Same as PRESsure4 above</i>	
VACuum	Ps Vacuum
<i>Same as PRESsure4 above</i>	
VACuum11	Qc Vacuum
<i>Same as PRESsure4 above</i>	
TEMPerature2	Ps Sensor Temperature
<i>Same as PRESsure4 above</i>	

TEMPerature12 <i>Same as PRESSure4 above</i>	Qc Sensor Temperature
DISPlay :ENABle ON OFF 1 0 :TEXT "<text>" [:PRESSure] :BGRaph <number> :PRESSure11 :BGRaph <number>	turns front panel display on/off display message on front panel set Ps bar graph maximum set Qc bar graph maximum
OUTPut [:PRESSure] :MODE MEASure CONTrol VENT :STATe ON OFF 1 0 :PRESSure11 :MODE MEASure CONTrol VENT :STATe ON OFF 1 0	Ps mode Ps off=MEASure, on=CONTrol Qc mode Qc off=MEASure, on=CONTrol
SENSe [:PRESSure] :RANGE [:UPPer]? :LOWer? :REFerence [:HEIGHt] <number> :MEDIum N2 AIR [:RESolution] <number> :AUTO ONCE :PRESSure11 :RANGE [:UPPer]? :LOWer? :REFerence [:HEIGHt] <number> :MEDIum N2 AIR [:RESolution] <number> :AUTO ONCE :TRATe? :RESet :STARt :TIME <minutes>,<seconds> :WAIT <minutes>,<seconds>	Ps Full scale value in units (calibrated) Ps Low cal point Ps gas head height Ps gas head medium Ps Pressure display resolution Returns to default resolution Qc Full scale value in units (calibrated) Qc Low cal point Qc gas head height Qc gas head medium Qc Pressure display resolution Returns to default resolution OFF WAITING TIMING TIMED Cancel rate timing Start rate timing Time Period for rate timing Wait Period for rate timing
[SOURce] :GTGRound :GTGRound? :LIMit :ARINc ON OFF 1 0 :AIRCraft STANDARD MAX ARINC :MACH ON OFF 1 0 :PRESSure ALT,<number> :PRESSure CAS,<number> :PRESSure MACH,<number> :PRESSure PS,<number>	Go to ground Returns 1 if safe at ground ARINC limit checking Mach limit disable Altitude Setpoint** Airspeed setpoint** Mach Setpoint Ps Pressure setpoint

:PRESsure PT,<number>	Pt Pressure setpoint
:PRESsure QC,<number>	Qc Pressure setpoint
[:PRESsure] <number>	Ps pressure control setpoint
:CONTRol	
:OFF <number>	Ps Control Off band
:ON <number>	Ps Control On band
:SLEW <number>	Ps slew rate
:TOLerance <number>	Ps output tolerance
:PRESsure11 <number>	Qc pressure control setpoint
:CONTRol	
:OFF <number>	Qc Control Off band
:ON <number>	Qc Control On band
:SLEW <number>	Qc slew rate
:TOLerance <number>	Qc output tolerance
:RATE ALT,<number>	Altitude rate setpoint**
:RATE CAS,<number>	Airspeed rate setpoint**
:RATE PS,<number>	Ps rate setpoint
:RATE PT,<number>	Pt rate setpoint
:RATE QC,<number>	Qc rate setpoint

STATus

:OPERation	
[:EVENT]?	read/clear operation event register
:CONDition?	read operation condition register
:ENABle <number>	set operation enable mask
:QUEStionable	
[:EVENT]?	read/clear questionable event register
:CONDition?	read questionable condition register
:ENABle	set questionable enable mask
:PRESet	clear enable masks

SYSTem

:BEEPer <freq>,<length>	<Freq> ignored
:DATE <year>,<month>,<day>	system date
:ERRor?	returns <error#,"descr;info"> or 0,"No Error"
:KLOCK ON OFF 1 0	keyboard lock
:TIME <hour>,<minute>,<sec>	system time
:VERsion?	SCPI protocol version (returns 1991.0)
:LANGUage "COMP" "6610" "SCPI"	set interface emulation
:PRESet	reset pressure control
:COMMunicate	
:SERial	
:RECeive	
:TRANsmit	
:BAUD <number>	
:PARITY EVEN ODD NONE	
:BITS 7 8	
:SBITS 1 2	
:GPIB	
:ADDRes <number>	

TEST

:ELECTronic?	Run Elec Self-Test & Return Result
:STOP	Abort Pneu, Volume, or Leak

UNIT

:AERonautical FTKNTS	Feet, Knots
:AERonautical FTMPH	Feet, Miles/hour
:AERonautical MKPH	Meters, Kilometers/hour
:AERonautical MKPH(M/min)	Meters, Meters/minute
:AERonautical MKPH(M/s)	Meters, Meters/second
:AERonautical MKPH(hM/min)	Meters, Hectometers/minute
:DEFine<n> <name>,<number>	Create Unit
:DISPlay <name>Ps Units on Display	
:DISPlay11 <name>	Qc Units on Display
:LENGth MM IN	set length units (head height)
[:PRESsure] <name>	set pressure units
:TEMPerature C CEL F FAR K	set temperature units
:VACuum MICRON MTORR PA <name>	set vacuum units

**Units for this command are set by UNIT:AER.

5.4.5 EXAMPLE SCPI COMMANDS

To request the current pressure reading, all of the following commands are equivalent:

```
:MEASURE:PRESSURE?  
:measure:pressure?  
:MeAsUrE:pReSsUrE?  
:meas:pres?  
:measure?  
:meas?  
MEAS?
```

To set the control pressure setpoint to 50, all of the following commands are equivalent:

```
SOURCE:PRESSURE:LEVEL:IMMEDIATE:AMPLITUDE 50  
SOUR:PRES:LEV:IMM:AMPL 50.0  
PRESSURE +50  
PRES 50
```

To zero the unit via the remote interface use the following sequence:

```
CAL:ZERO:INIT      Enter Zero Mode  
CAL:ZERO:INIT?    Read Status (Mode, Pressure, Temperature, Reference)  
                  and Wait Until Stable.  
CAL:ZERO:RUN      Start Zero Adjust Sequence  
STAT:OPER:COND?   Wait Until Complete (Bit 0 = 0)
```

5.4.6 SCPI STATUS REGISTERS

Three type of status registers are available: Condition, Event, and Enable.

Condition registers always show the current status of the instrument. Bits may turn on and back off between reads. The status read is the status of instrument at the moment of the read. Condition registers include:

*STB?	Status Byte Register
*ESR?	Standard Event Status Register
STAT:OPER:COND?	Operation Status Condition Register
STAT:QUES:COND?	Questionable status Condition Register

Event registers do not show the current state but flag the bits in the condition registers that have changed since the last time the event register was read. When an event register is read it is reset to zero.

STAT:OPER:EVENT? Operation Status Event Register
STAT:QUES:EVENT? Questionable Status Event Register

Enable registers are set by the user to create summary bits. If the user sets a bit in the enable register, when the instrument sets the corresponding bit in the event register a summary bit in the Status Byte Register is set.

*ESE
STAT:OPER:ENAB
STAT:QUES:ENAB

The Service Request Enable Register (*SRE) is used to generate service requests on the IEEE-488 bus. If a user sets a bit in this register, when the instruments sets the corresponding bit in the Status Byte Register (*STB) a service request is generated.

*SRE

Status Byte (*STB)

Bit 7 Operation Summary
Bit 6 Service Request
Bit 5 Event Summary
Bit 4 Message Available
Bit 3 Questionable Summary
Bit 2 Error Available
Bit 1 *reserved*
Bit 0 *reserved*

Event Status Register (*ESR)

Bit 7 Power lost
Bit 6 *reserved*
Bit 5 Command error
Bit 4 Execution error
Bit 3 Device error
Bit 2 Query error
Bit 1 *reserved*
Bit 0 Operation Complete

Operation Status Register (STAT:OPER)

Bit 14 Program running
Bit 13 *reserved*
Bit 12 *reserved*
Bit 11 *reserved*
Bit 10 *reserved*
Bit 9 *reserved*
Bit 8 Self-Test running
Bit 7 *reserved*
Bit 6 *reserved*
Bit 5 *reserved*
Bit 4 Measuring
Bit 3 *reserved*
Bit 2 Qc Settling
Bit 1 Ps Settling

Bit 0 Calibrating

Questionable Status Register (STAT:QUES)

Bit 14 Command Warning
Bit 13 *reserved*
Bit 12 *reserved*
Bit 11 *reserved*
Bit 10 *reserved*
Bit 9 *reserved*
Bit 8 Pressure reading questionable
Bit 7 Pressure not calibrated
Bit 6 *reserved*
Bit 5 *reserved*
Bit 4 *reserved*
Bit 3 Oven temperature questionable
Bit 2 Time not set
Bit 1 *reserved*
Bit 0 Supply voltages questionable

5.5 SERIAL OPERATION

The RS-232 port accepts the same SCPI commands as the IEEE-488 port. The commands can be terminated by a carriage return (hexadecimal 0D) or a line feed (hexadecimal 0A). The responses are always terminated by a carriage return followed by a line feed.

The serial port also supports XON/XOFF. When the XOFF (hexadecimal 13) command is received, the ADTS will stop transmitting. Transmission is restarted when the XON (hexadecimal 11) command is received.

When only one unit is attached, the Control-C (hexadecimal 03) command will clear the transmit and receive buffers and disable addressing. When addressing is disabled, the unit will respond to commands without being addressed.

5.6 SAMPLE PROGRAMS

5.6.1 Sample Program 1 - 7750i GPIB (IEEE-488)- Controls pressure to 20.000 %FS

```
/*-----*/  
/*     Sample Program 1 - 7750 GPIB (IEEE-488)     */  
/*     Controls pressure to 20.000 %FS     */  
/*-----*/  
#include <stdio.h>  
#include <stdlib.h>  
#include <string.h>  
#include <conio.h>  
  
#include "decl.h"  
  
/*-----*/  
  
int     device;                     /* GPIB Device descriptor */  
char    buffer[256];               /* buffer for input/output strings */  
double  pressure;                  /* Pressure read from unit */  
int     status;                    /* Status register from unit */  
  
int     check_errors (void);  
void    write_7000 (char *s);  
void    request_7000 (char *s);
```

```

/*-----*/
void main (void)
{
    char *p;

    /*-----*/
    /* Initialize GPIB Interface */
    /*-----*/
    device = ibdev (0,          /* First GPIB Board */
                   4,          /* GPIB Address of 7010 */
                   NO_SAD,     /* No secondary addressing */
                   T1S,        /* 1 Second Timeout */
                   0,          /* No automatic EOI for transmit */
                   REOS+LF);   /* Terminate read on Line Feed */

    if (ibsta & ERR)
        { printf ("GPIB Driver not installed.\n");
          return;
        }

    /*-----*/
    /* Initialize 7750 Interface */
    /*-----*/
    /*
    /*     UNIT %FS           Set units to percent of full scale */
    /*     PRES 20.0         Set control setpoint to 20 %FS      */
    /*     PRES:TOL 0.001    Set control tolerance to 0.001 %FS */
    /*     OUTP:MODE CONTROL Enter control mode                */
    /*-----*/
    write_7000 ("UNIT %FS;:PRES 20.0;TOL 0.001;:OUTP:MODE CONTROL\n");

    if (check_errors ( ))
        { ibonl (device, 0);
          return;
        }

    /*-----*/
    /* Read pressure status until setpoint is reached. */
    /*-----*/
    /*
    /*     MEAS?             Read pressure                      */
    /*     STAT:OPER:COND?   Read status setpoint              */
    /*-----*/
    while (!kbhit ( ))
        { request_7000 ("MEAS?;:STAT:OPER:COND?\n");
          pressure = strtod (buffer, &p);
          status   = atoi (++p);

          if (check_errors ( ))
              continue;

          if (status & 0x10)
              printf ("Pressure = %9.3lf\n", pressure);
          if ((status & 2) == 0)
              break;
        }

    /*-----*/
    /* Reset 7750 to Measure mode */
    /*-----*/
    /*
    /*     OUTP:MODE MEASURE Enter Measure mode */
    /*-----*/
    write_7000 ("OUTP:MODE MEASURE\n");

    check_errors ( );

    /*-----*/
    /* Reset GPIB Interface */
    /*-----*/

```



```

    ibonl (device, 0);
}

/*-----*/
/* check_errors : display all GPIB and 7750 error messages          */
/*               return TRUE if any errors were found              */
/*-----*/
int check_errors (void)
{
    unsigned char status7;
    int retval;

    /*-----*/
    /* Check for GPIB Interface Errors */
    /*-----*/
    if (ibsta & ERR)
        { printf ("GPIB Status=%4X Error=%d\n");
          return 1;
        }

    /*-----*/
    /* Check for 7750 Errors */
    /*-----*/
    retval = 0;
    while (!kbhit ( ))
        { ibrsp (device, &status7);          /* Serial poll */
          if ((status7 & 4) == 0)           /* Check error bit */
              break;
          retval = 1;
          request_7000 ("SYST:ERR?\n");     /* Get error message */
          printf (buffer);
        }
    return retval;
}

/*-----*/
/* write_7000 : write a command to the 7250                        */
/*-----*/
void write_7000 (char *s)
{
    ibwrt (device, s, strlen (s));
}

/*-----*/
/* request_7000 : write a query command and read the response      */
/*-----*/
void request_7000 (char *s)
{
    ibwrt (device, s, strlen (s));
    ibrd (device, buffer, sizeof (buffer));
}

/*-----*/

```

5.6.2 Sample Program 2 - 7750i GPIB (IEEE-488)- ZERO Sequence

```

/*-----*/
/*      Sample Program 2 - 7750 GPIB (IEEE-488)                    */
/*      Zero Sequence                                              */
/*-----*/
#include <stdio.h>
#include <stdlib.h>
#include <string.h>
#include <conio.h>

#include "decl.h"

/*-----*/

int    device;                /* GPIB Device descriptor */

```

```

char  buffer[256];          /* buffer for input/output strings */
double pressure;          /* Pressure read from unit */
int    status;             /* Status register from unit */

int    check_errors (void);
int    zero (void);
void   write_7000 (char *s);
void   request_7000 (char *s);
/*-----*/

void main (void)
{
    char *p;

    /*-----*/
    /* Initialize GPIB Interface */
    /*-----*/
    device = ibdev (0,          /* First GPIB Board */
                   4,          /* GPIB Address of 7750 */
                   NO_SAD,     /* No secondary addressing */
                   T1s,        /* 1 Second Timeout */
                   0,          /* No automatic EOI for transmit */
                   REOS+LF);   /* Terminate read on Line Feed */

    if (ibsta & ERR)
        { cprintf ("GPIB Driver not installed.\n");
          return;
        }

    /*-----*/
    /* Zero 7010 */
    /*-----*/
    if (!zero ( ))
        { ibonl (device, 0);
          return;
        }

    /*-----*/
    /* Reset GPIB Interface */
    /*-----*/
    ibonl (device, 0);
}

/*-----*/
/* Zero : perform zero adjust of 7750 */
/*-----*/
int zero (void)
{
    int cstat, pstat, tstat, rstat;

    clrscr ( );
    cprintf ("Zeroing");

    gotoxy (1, 5); cprintf ("Pressure Reading");
    gotoxy (1, 6); cprintf ("Sensor Temperature");
    gotoxy (1, 7); cprintf ("Reference Pressure");

    /*-----*/
    /* Enter Zero Mode */
    /*      CAL:ZERO:INIT */
    /*-----*/
    write_7000 ("CAL:ZERO:ALL:INIT\n");

    /*-----*/
    /* Wait for zero to complete */
    /*      STAT:OPER:COND? */
    /*-----*/
    do
        { request_7000 ("STAT:OPER:COND?\n");

```

```

        sscanf (buffer, "%d", &status);

        if (check_errors ( ))
            return 0;

        gotoxy (1, 9);
        cprintf ("Zeroing");
    }
    while ((status & 1) != 0);

    gotoxy (1, 9);
    cprintf ("Zero Complete");
    return 1;
}

/*-----*/
/* check_errors : display all GPIB and 7750 error messages */
/*               return TRUE if any errors were found */
/*-----*/

int check_errors (void)
{
    unsigned char status7;
    int retval;

    /*-----*/
    /* Check for GPIB Interface Errors */
    /*-----*/
    if (ibsta & ERR)
        { cprintf ("GPIB Status=%4X Error=%d\r\n", ibsta, iberr);
          return 1;
        }

    /*-----*/
    /* Check for 7750 Errors */
    /*-----*/
    retval = 0;
    while (!kbhit ( ))
        { ibrsp (device, &status7);           /* Serial poll */
          if ((status7 & 4) == 0)           /* Check error bit */
              break;
          retval = 1;
          request_7000 ("SYST:ERR?\n");     /* Get error message */
          cprintf (buffer);
        }
    return retval;
}

/*-----*/
/* write_7000 : write a command to the 7250 */
/*-----*/
void write_7000 (char *s)
{
    ibwrt (device, s, strlen (s));
}

/*-----*/
/* request_7000 : write a query command and read the response */
/*-----*/
void request_7000 (char *s)
{
    ibwrt (device, s, strlen (s));
    ibrd (device, buffer, sizeof (buffer));
}
/*-----*/

```

5.6.3 Sample Program 3 - 7750i SERIAL(RS-232)- Controls pressure to 20.000 %FS

```

/*-----*/
/*      Sample Program 3 - 7750 Serial (RS-232)      */
/*-----*/
/*      Controls pressure to 20.000 %FS      */
/*-----*/
#include <stdio.h>
#include <stdlib.h>
#include <conio.h>
#include <dos.h>
#include <time.h>

#define TRUE 1
#define FALSE 0

#define TIMEOUT (CLK_TCK * 5) /* 5 second timeout */
#define XON 0x11
#define XOFF 0x13
#define CLEAR 0x03
#define DLE 0x10
#define QUEUE_SIZE 1024

char  buffer[QUEUE_SIZE]; /* buffer for input/output strings */
double pressure; /* Pressure read from unit */
int  status; /* Status register from unit */

int  address;
int  portbase;
int  intnum;
volatile int  transmit_enabled = TRUE;
char inqueue[QUEUE_SIZE];
int  inq_in;
int  inq_out;
void interrupt (*old_vector) ( );

int  check_errors (void);
void serial_initialize (void);
void write_7000_serial (char *s);
void serial_close (void);
int  request_7000_serial (char *s);
void serial_write (char ch);

/*-----*/

void main (void)
{
    char *p;

    /*-----*/
    /* Initialize Serial Interface */
    /*-----*/
    address = 4;
    serial_initialize ( );

    /*-----*/
    /* Initialize 7750 Interface */
    /*-----*/
    /*      UNIT %FS      Set units to percent of full scale */
    /*      PRES 20.0      Set control setpoint to 20 %FS */
    /*      PRES:TOL 0.001 Set control tolerance to 0.001 %FS */
    /*      OUTP:MODE CONTROL Enter control mode */
    /*-----*/
    write_7000_serial ("UNIT %FS;:PRES 20.0;:TOL 0.001;:OUTP:MODE CONTROL\n");

    if (check_errors ( ))
        { serial_close ( );
          return;
        }
}

```

```

    }

/*-----*/
/* Read pressure status until setpoint is reached. */
/*                                     */
/*     MEAS?           Read pressure      */
/*     STAT:OPER:COND? Read status setpoint */
/*-----*/
while (!kbhit ( ))
{ if (!request_7000_serial ("MEAS?;:STAT:OPER:COND?\n"))
    { printf ("Timeout\n");
      continue;
    }
  pressure = strtod (buffer, &p);
  status   = atoi (++p);

  if (check_errors ( ))
    continue;

  if (status & 0x10)
    printf ("Pressure = %9.3lf\n", pressure);
  if ((status & 2) == 0)
    break;
}

/*-----*/
/* Reset 7750 to Measure mode          */
/*                                     */
/*     OUDP:MODE MEASURE  Enter Measure mode */
/*-----*/
write_7000_serial ("OUDP:MODE MEASURE\n");
check_errors ( );

/*-----*/
/* Reset Serial Interface */
/*-----*/
serial_close ( );
}

/*-----*/
/* check_errors : display all 7750 error messages          */
/*                                     */
/*     return TRUE if any errors were found                */
/*-----*/
int check_errors (void)
{
  unsigned char status7;
  int retval;

  /*-----*/
  /* Check for 7750 Errors */
  /*-----*/
  retval = 0;
  while (!kbhit ( ))
    { if (!request_7000_serial ("*STB?\n"))
        { printf ("Timeout\n");
          return TRUE;
        }
      status7 = atoi (buffer);
      if ((status7 & 4) == 0)                /* Check error bit */
        break;
      retval = 1;
      request_7000_serial ("SYST:ERR?\n");    /* Get error message */
      printf (buffer);
    }
  return retval;
}
/*-----*/

```

```

/* serial_int : receive interrupt for serial port */
/*-----*/
void interrupt serial_int ( )
{
    char ch;

    if ((inportb (portbase + 2) & 0x07) == 0x04)
    { ch = inportb (portbase);
      if (ch == XON)
          transmit_enabled = TRUE;
      else if (ch == XOFF)
          transmit_enabled = FALSE;
      else
          { inqueue[inq_in++] = ch;
            if (inq_in == QUEUE_SIZE)
                inq_in = 0;
          }
    }
    outportb (0x20, 0x20);
}
/*-----*/
/* serial_initialize : initialize serial port */
/*-----*/
void serial_initialize ( )
{
    char msg[10];
    int divisor;
    unsigned v;

    portbase = 0x3F8;          /* COM1 = 0x3F8, COM2 = 0x2F8 */
    intnum = 4;               /* COM1 = 4, COM2 = 3 */
    outportb (portbase + 3, 0x80);
    outportb (portbase + 1, 0);
    outportb (portbase, 0x0C); /* 9600 Baud */
    outportb (portbase + 3, 3); /* 8 Databits, No Parity, 1 Stopbit */

    old_vector = getvect (intnum + 8); /* Save old interrupt vector */
    setvect (intnum + 8, serial_int); /* Set new interrupt vector */

    v = inportb (0x21); /* Enable interrupt */
    v &= ~(1 << intnum);
    outportb (0x21, v);

    outportb (portbase + 1, 0x01); /* Enable receive interrupt */
    outportb (portbase + 4, 0x0B); /* Enable Interrupt, DTR, RTS */

    serial_write (CLEAR);
}
/*-----*/
/* serial_close : turn off serial receive interrupt */
/*-----*/
void serial_close ( )
{
    unsigned v;

    outportb (portbase + 1, 0);
    outportb (portbase + 4, 0);
    v = inportb (0x21);
    v |= 1 << intnum;
    outportb (0x21, v);
    setvect (intnum + 8, old_vector);
}
/*-----*/
/* serial_write : write a single character to serial port */
/*-----*/
void serial_write (char ch)

```

```

{
    while (!transmit_enabled)
        ;
    while ((inportb (portbase + 5) & 0x20) == 0)
        ;
    outportb (portbase, ch);
}
/*-----*/
/* write_7000_serial : write a string to the correct 7750          */
/*-----*/
void write_7000_serial (char *s)
{
    if (address == -1)
        serial_write (CLEAR);           /* Disable Addressing */
    else
        { serial_write (DLE);           /* Enable Addressing */
          serial_write (address + 0x20); /* Address */
        }
    while (*s)
        serial_write (*s++);           /* Write string */
}
/*-----*/
/* request_7000_serial : write a commmand and read the response  */
/*-----*/
int request_7000_serial (char *s)
{
    int i;
    char ch;
    clock_t start, current;

    write_7000_serial (s);             /* Write Command */
    i = 0;
    while (i < QUEUE_SIZE - 1)
        { start = clock ( );
          while (inq_in == inq_out)     /* Wait for a character */
              { current = clock ( );
                if (current < start)
                    current += CLK_TCK * 86400;
                if (current - start > TIMEOUT) /* Check for timeout */
                    { buffer[i] = 0;
                      return FALSE;
                    }
              }
          ch = inqueue[inq_out++];      /* Put character in buffer */
          if (inq_out == QUEUE_SIZE)
              inq_out = 0;
          if (ch == 0x0A)               /* Line Feed? - End of response */
              { buffer[i] = 0;
                return TRUE;
              }
          else
              buffer[i++] = ch;
        }
    buffer[QUEUE_SIZE - 1] = 0;        /* Buffer full */
    return FALSE;
}
/*-----*/

```

5.6.4 Sample Program 4 - QBASIC EXAMPLE FOR 7750i

```
REM $INCLUDE: 'C:\GPIB-PC\QBDECL.BAS'  
DIM READING AS STRING*30  
CALL IBDEV(0,4,0,12,1,&H40A,R7010%)  
CALL IBCLR(R7010%)  
CALL IBWRT(R7010%,"MEAS?" + chr$(&H0A))  
CALL IBRD(R7010%,READING$)  
PRINT READING$  
CALL IBONL(R7010%,0)  
END
```

Note: EOM & EOS are linefeed

SECTION 6.0 MAINTENANCE

6.1 INTRODUCTION

Very little maintenance is required for the ADTS. This section of the manual discusses suggested maintenance procedures.

6.2 OBSERVING THE SOFTWARE VERSION NUMBER

Follow the steps below to observe the ADTS's software version number.

1. If necessary, press [PREVIOUS] several times to return the display to the Main Dual Display Menu.
2. Select MENU | MENU | SETUP | SYSTEM. The software version number will appear on the screen.
3. Press [PREVIOUS] to return to the previous screen.

6.3 PREVENTIVE MAINTENANCE

Although the ADTS is designed to be nearly maintenance free, occasional preventive maintenance is required to keep the ADTS's performance optimal.

6.3.1 INITIATING THE ADTS'S SELF TEST

To test the ADTS's hardware and software follow the steps below.

1. If necessary, press [PREVIOUS] several times to return the display to the Main Dual Display Menu then press the **MODE** key to select the channel main menu.
2. Select MENU | MENU | TEST | SELF

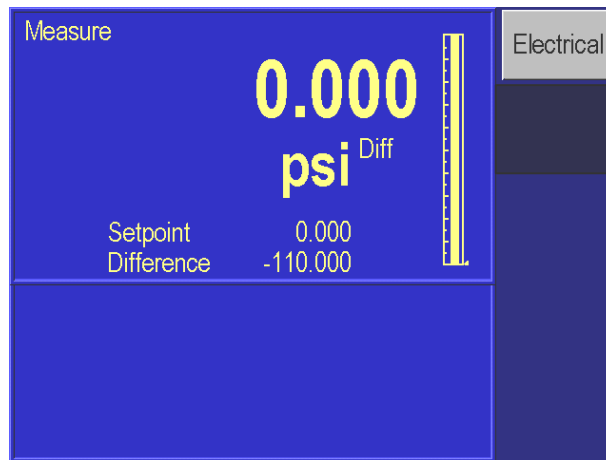

MENU | MENU | TEST | SELF

3. Press ELECTRICAL [F1]. The electronics self test will run and display the results.

The electronics test runs eight sets of tests on various parts of the electronic modules. Table 6-1 describes these tests and the possible actions needed if a test fails. The pneumatics test runs nine tests on the pneumatics module. Table 6-2 describes these tests and the possible actions needed if a test fails.

Test	Description	Action on failure	GE Part #
Processor	Tests the processor chip	Replace processor board.	7215-586-3
Clock	Tests the real time clock	Replace processor board.	7215-586-3
Timer	Tests the 10 ms interval timer	Replace processor board.	7215-586-3
EEPROM	Tests the nonvolatile memory	Replace processor board.	7215-586-3
Oven	Tests operation of the sensor oven	Replace sensor assy. Allow oven to warm up.	Contact GE

**TABLE 6-1
ELECTRONICS SELF TEST**

6.3.2 REMOVING THE ADTS'S COVER

The ADTS should be kept clean and completely assembled at all times. Operating the ADTS without its cover affects the ADTS's thermal gradients and therefore may reduce precision. If it becomes necessary to remove the ADTS's cover, follow the instructions below.

CAUTION: The ADTS should only be opened by qualified electrical/mechanical service technicians. Lethal voltages are present and exposed in the power supply and display.

1. Turn off the ADTS and disconnect the power cord from the ADTS.
2. Locate and unscrew the four screws that secure the cover to the back panel.
3. Place your hands near the middle of the cover and slide the cover towards the ADTS's back panel.
4. Lift up on the cover. With the cover removed, use typical electronic cleaning tools to remove any accumulated dust from inside the instrument.
5. Replace the cover before resuming operation.

6.3.3 MOISTURE FILTER

The Bourdon tube sensor is hygroscopic. An external desiccant filter prevents introduction of moisture and is strongly recommended for high humidity areas. The filter should be replaced annually. The moisture filter is used with the reference port only (absolute only instruments do not need a moisture filter).

6.3.4 PARTICLE FILTERS

Refer to Appendix A for air supply quality requirements. During normal operation, the ADTS transfers gas both into and out of the device under test (DUT). When necessary, the user is expected to use and maintain an in-line disposable particle filter to protect the ADTS's pneumatics from any contamination that may exist in the DUT.

6.3.5 VACUUM PUMPS

Periodic checks of the user's vacuum pumps for oil levels. It is very highly recommended that a power-down vacuum venting valve is installed onto the vacuum pumps to ensure minimal chances of oil contamination from the vacuum sources. These are normally open solenoid valves that are powered through the vacuum pump power switch. When the vacuum pump is turned on, the solenoid valve is energized and closes allowing the pump to operate normally. When the pump is turned off, power is removed from the solenoid and the vacuum is vented to atmosphere. Periodic changing of vacuum pump oil as recommended by the vacuum pump manufacturer should also be done.

6.3.6 PROCESSOR BATTERY

The processor board uses a lithium battery to maintain time and date information. This battery has a varying life. If the instrument is left on 24 hours a day, it may last 5 to 10 years. If the instrument is stored, it may only last one year. Annual replacement is recommended. To replace the battery:

1. Turn off power and remove the instrument cover. (See Section 6.3.2.)
2. Remove the processor card by removing the screw and the bracket that locks the display cable in place and gently rock the card upward.
3. Holding the processor card, remove the battery (the round silver object), by carefully pulling on the battery.
4. Plug in a new battery (RIC # 4-725).
5. Reinstall the processor card, the bracket that locks the display cable in place and the screw. Replace the instrument cover.
6. The time and date may have to be re-entered. See Section 4.6.1.5.

6.4 CALIBRATION

To keep the ADTS operating within its specified precision, the calibration procedure described below should be performed once every year. If a higher level of overall performance is desired, the user can calibrate more frequently.

NOTE: The calibration procedure automatically generates coefficients that are stored in memory on the ADTS's. If these constants are "lost" for any reason, the calibration procedure must be performed, regardless of the last calibration date. If the calibration coefficients have been recorded, they may be restored to the ADTS at any time by "editing the coefficients" (Section 6.4.3).

6.4.1 CALIBRATION INSTRUCTIONS

To calibrate the ADTS, the user connects a calibration standard such as the GE Ruska Model 2465 or 2468 Gas Piston Gauge to the ADTS's test port, then follows the multi-step calibration procedure on the ADTS's display. The standard ADTS requires a positive pressure calibration. No disassembly is required and there are no potentiometers to tune.

NOTE: The uncertainty of the final calibration must include the uncertainty of the pressure standard being used.

6.4.1.1 Preparation

1. When calibrating the Qc channel, verify that the Ps Test Port is open to atmosphere and that the calibration standard is connected to the Pt Test Port. When calibrating the Ps channel, verify that the calibration standard is connected to the Ps test port.
2. Verify that the ADTS has been at stable environmental temperature and that the oven temperature (MENU | MENU | DISPLAY | TEMPERATURE) has been stable for at least three hours.
3. Verify that the ADTS is in Measure mode (Section 4.0).
4. If desired, change the ADTS's engineering units of measure (Section 4.0) to match those of the calibration standard.
5. Set the gas head to 0 for both channels. Select MENU | MENU | SETUP | USER (Press the **[MODE]** key to toggle between the Ps and the Qc channels and verify that they are both set to 0.)
6. To access the calibration screen, select MENU | MENU | CALIBRATION| CALIBRATION.



7. When you first enter the Calibration menu, the top left hand side of the display will indicate which sensor is being the viewed. The sensors coefficients are then shown below the sensor label. On the 7750i, there are two primary sensors. The first sensor that is shown is the Ps sensor. To switch to the various sensors that exist in the system, you would press the Sensor [F6] function key. Assure that you are in the screen that is labeled Ps Primary or Qc Primary depending on which channel is being calibrated.
8. To begin the calibration process, press the Calibrate [F2] button. If the calibration access code is enabled, enter it at the prompt. The first calibration screen will appear.

NOTE: To exit the calibration procedure before the calibration coefficients have been changed; press [CANCEL] any time during the procedure. Canceling restores all previous calibration values.

Step 1

- 1.1 The first step automatically performs the sensor zeroing routine. Please read the section in the manual regarding zeroing the sensors. It is critical that a good zero is set in the calibration process. You will need the Ps sensor to be evacuated to less than 100 mtorr as read by the internal vacuum sensor and stable before proceeding with a zero. It is recommended to start evacuating the Ps sensor during the warm up period.
- 1.2 Wait until the zero procedure finishes. This may take several minutes. When the ADTS completes step 1, the calibration screen will appear.

Step 2

- 2.1 To begin step 2, use the calibration standard to apply the various pressures that will be requested by the 7750i. The screen will display a table noting the following information;
Step – The pressure step in the calibration sequence
Apply – The pressure that the standard is to generate to the ADTS.
Tolerance – The tolerance about the apply value that can be generated by the standard and still accepted by the ADTS.
Actual – The actual pressure value that was generated by the standard when the point was accepted.
Adj. %FS – Depicts the amount that the ADTS corrected its output to align to the standard. This is used as a trouble-shooting tool. If one point has a significantly higher adjustment required than other points in the calibration, this may indicate that there was an error in that specific calibration point. The operator can re-check this pressure point prior to completing and accepting the full calibration.
- 2.2 The Step 1, actual value will be highlight. This is your first pressure point in the calibration procedure.
- 2.3 Using your calibration standard, generate the pressure shown in the Apply column. When the measured pressure stabilizes, use the ADTS's numeric keypad to enter the actual pressure applied by the calibration standard and then press ENTER. Do not enter the measured pressure reported by the ADTS. If necessary, use the [CLEAR] key to correct a mistake in the edit field. If the actual pressure applied is within the indicated tolerance, the unit will accept that point and the highlighted cursor will automatically scroll down to the next calibration step.

NOTE: If the actual pressure is outside of the tolerance for the requested mid-point pressure, *Error –222 Data out of range* will occur. Acknowledge this error by selecting OK [F6], then re-enter the actual pressure, repeating step 2.1 if necessary.

Step 3

- 3.1 Generate the next pressure calibration point requested by the ADTS. Apply this pressure using calibration standard and follow the instructions in Step 2.3, entering the actual pressure applied.
- 3.2 Repeat this procedure until all of the calibration steps are complete. Review the Adj. %FS field to see if one point has a significantly higher adjustment required than other points in the calibration. This may indicate that there was an error in that specific calibration point. The operator can re-check this pressure point prior to completing and accepting the full calibration. To re-enter a point, use the rotary knob and move the highlighted cursor to the actual pressure values in the step in question. Generate the requested apply pressure using the standard and enter then new actual value when stabilized.

6.4.1.2 Storing the Coefficients

Step 4

- 4.1 Calibration is complete. To exit the calibration procedure without storing the calibration coefficients in memory, press [CANCEL]. To store the calibration coefficients in memory, select the Done [F1] key and the ADTS will calculate all of its new coefficients.

NOTE: In addition to saving the calibration coefficients to the ADTS's memory, the user is advised to separately record the calibration coefficients and store this "backup" in a safe place.

Step 5

- 5.1 Press [PREVIOUS] to return to the Main Menu.
- 5.2 Once the calibration procedure is complete, the user should verify several pressure readings against the pressure standard. If there are variances beyond the stated precision, then an error was probably made in generating one of the calibration pressures, and the calibration procedure should be repeated.

6.4.2 VACUUM SENSOR CALIBRATION – Ps ZEROING VACUUM SENSOR

A span correction can be applied to the vacuum sensor. This correction is done using the ADTS software and can be performed without removing the vacuum sensor from the ADTS chassis.

1. Place the ADTS in Measure mode. Remove all pressure sources from the system.
2. The Vacuum sensors are located inside the black sensor oven assembly. Connect a pressure standard physically as close to the vacuum sensor as possible. You may wish to remove the top cover of the instrument and connect directly to the pressure ports going into the quartz sensor oven assembly.
3. If desired, change the ADTS's units of measure (see Section 4) to match those of the calibration standard.
4. To access the Calibration screen, from the Main Menu, select MENU | MENU | CALIBRATE | CALIBRATE.

5. Select the atmospheric sensor by pressing the Sensor [F6] key until the words Vacuum Sensor is displayed above the calibration coefficients.
6. To begin the calibration process, press CALIBRATE. If the calibration access code is enabled, enter it at the prompt. The first Calibration screen will appear.
7. You will use the calibration standard to apply the two vacuum points on the vacuum sensor.
8. The Actual value will be highlighted. This is your first pressure point in the calibration procedure. This calibration requires the generation of two pressures within the range of 50 to 350 mtorr absolute. The selected pressures should be spaced as far apart as possible within the allowable range.
9. Generate the first pressure. Enter the actual value of the applied pressure generated by the standard and press [ENTER].
10. Generate the second pressure. Enter the actual value of the applied pressure generated by the standard and press [ENTER].
11. The Vacuum sensor is now linearly compensated. Once the calibration procedure is complete, the user should verify several pressure readings against the pressure standard. If there are variances beyond the stated precision, then an error was probably made in generating one of the calibration pressures, and the calibration procedure should be repeated.
12. If the instrument is fitted with two vacuum sensor, calibrate the second vacuum sensor.
13. Remove the vacuum standard from the instrument.
14. Reinstall the cover onto the 7750i.

6.4.3 EDITING THE CALIBRATION COEFFICIENTS

If the ADTS's memory is erased but the calibration coefficients are known, the user can restore the coefficients to the ADTS by following the directions below.

CAUTION: Never randomly adjust the calibration coefficients. Only qualified personnel with valid backup data should be allowed to edit the coefficients. If the backup coefficients are questionable, perform the calibration procedure in its entirety.

1. Verify that the ADTS is in Measure mode (Section 4.0).
2. Enter the Calibration screen by selecting MENU | MENU | CALIBRATE| CALIBRATE.
3. When you first enter the Calibration menu, the top line of the display will indicate which sensor is being the viewed. The sensors coefficients are then shown below the sensor label. The first sensor that is shown is the primary measuring sensor. This is indicated by the word Primary displayed in the top of the display. To cycle through the various sensors that exist in the system, you would press the Sensor [F6] function key. The two common sensors that would be calibrated would be the Ruska sensor which would be labeled as Primary and if the unit has the optional Barometric Reference sensor, this would be labeled as Atmospheric Sensor.

4. To edit the calibration coefficients, press the EDIT button. If the calibration access code is enabled, enter it at the prompt. The first calibration screen will appear.

NOTE: To exit the calibration procedure before the calibration coefficients have been changed, press [CANCEL] any time during the procedure. Canceling restores all previous calibration values.

5. Use the rotary knob to highlight the coefficient to be edited. The terms are coefficients of a linear regression analysis.
6. Use the numeric keypad and the [ENTER] key to enter a new value. To correct a mistake in the edit field, use the [CLEAR] key.
7. Repeat steps 4 and 5 until all coefficients are correct.

NOTE: In addition to saving the calibration coefficients to the ADTS's memory, separately record the calibration coefficients and store this "backup" in a safe place.

8. To exit the editing procedure without storing the calibration coefficients in memory, press [CANCEL]. To store the calibration coefficients in memory, select DONE [F6].
9. Press [PREVIOUS] to return to the Main Menu.

Once the calibration coefficients are input, the user should record several pressure readings. If there are any variances beyond the stated precision at these points, then the calibration procedure should be performed.

6.4.4 ZEROING

The zeroing procedure is performed to correct for system zero shift and does not require a full calibration. The most important requirement for performing a valid zeroing procedure is to guarantee that there is not a pressure differential between the sensor's test port and case reference.

If during the zeroing procedure, the message "Mechanical Zeroing Needed" appears, the sensor photocell may need to be zeroed. See Section 6.5 for more information.

The zeroing screen presents several pieces of information.

The screen will display the current status of the pressure sensor Stability and Temperature.

If any of the above are unstable, then the system will delay until stability is achieved. Pressing OK [F6] will bypass this wait period.

NOTE: Bypassing this wait period can have a negative effect on the zeroing procedure.

6.4.4.1 Qc channel

1. Verify that the Ps and Qc sensors are close to atmospheric pressure.
2. Enter the Calibration screen by selecting MENU | MENU | CALIBRATION.
3. Select Zero [F1]. Do NOT press the Calibrate button.

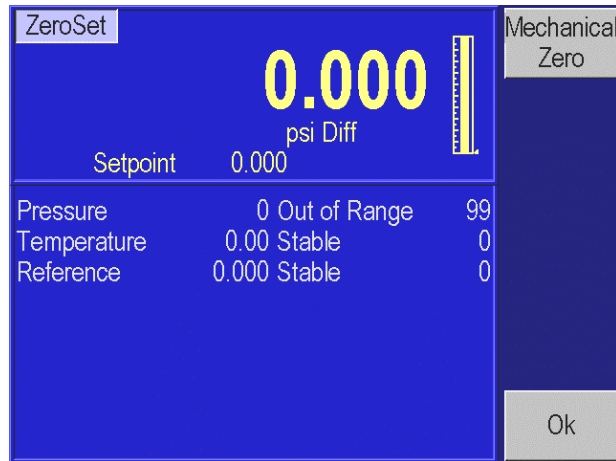

4. Do not disturb the instrument while zeroing is in process.
5. Wait for the zeroing procedure to finish.

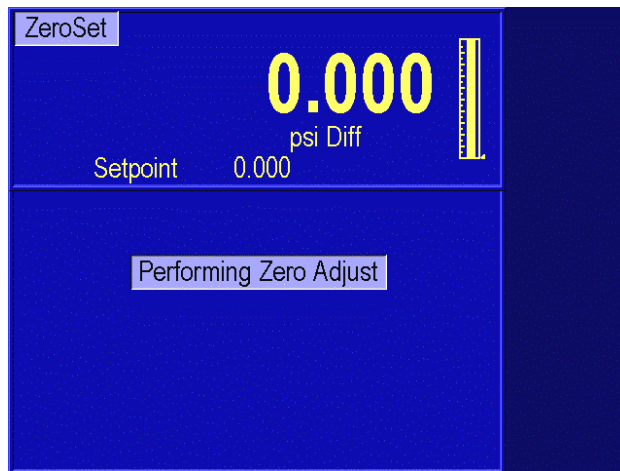

6. Press [PREVIOUS] to return to the Main Menu.

6.4.4.2 Ps Absolute Sensor

A high capacity vacuum pump must be connected to the rear reference port connector.

The 7750i has a Vacuum Sensor mounted internal to the primary sensor housing that monitors the vacuum level of the Ps sensor when the sensor is being zeroed. This sensor reading will display a value of 350 mtorr when the vacuum level is at or greater than 350 mtorr.

1. Select the desired vacuum units using the UNITS key. You can change both the unit of measure that the ADTS is displaying Pressure and the unit of measure for the vacuum sensor. It is not required to have the ADTS displaying pressure in the same unit of measure as the vacuum sensor. To change the unit of measure for the Vacuum sensor, press the UNIT key and then the Vacuum [F2] key.
2. Enter the Calibration screen by selecting MENU | MENU | CALIBRATE.
3. Select Zero [F1]. Do NOT press the Calibrate button. When initiating the zeroing command in the ADTS, it will cycle the internal valves allowing the external vacuum pump to pull a hard vacuum on the Ruska sensor. It is recommend that the sensor be

pulled down to a vacuum of less than 200 mTorr (preferably less than 100 mTorr) in order to obtain a proper zero. The ADTS can be zeroed at higher vacuum levels, however, the uncertainty of vacuum sensors tend to increase at higher vacuum levels, therefore, the uncertainty in the ADTS would also increase if zeroed at higher vacuum levels.

4. Wait for the vacuum level to stabilize as read by the internal vacuum sensor. Generally you want the stability to be better than 5 mtorr per minute.
5. Verify that the primary sensor pressure and temperature are stable.
6. Press OK [F6] when stable.
7. Do not disturb the instrument while zeroing is in process.
8. Wait for the zeroing procedure to finish.
9. Press [PREVIOUS] to return to the Main Menu.

6.5 SENSOR PHOTOCCELL ZEROING

If the error message “Mechanical Zeroing Needed” is displayed, the sensor photocell must be zeroed. The following steps describe this process. Press the MODE key to select the desired channel.

CAUTION: The ADTS should only be opened by qualified electrical/mechanical service technicians. Lethal voltages are present and exposed in the power supply and display.

NOTE: The Qc sensor MUST have zero differential pressure between the Test Pt port and Reference Ps port. The Ps sensor requires a vacuum of <200 mtorr.

1. Remove the ADTS’s top cover.
2. Locate and remove the plastic zeroing plug located in the side of the sensor oven assembly.
3. Enter the Zeroing screen by selecting MENU | MENU | CALIBRATE.
4. Select the Primary sensor by pressing the Sensor [F6] key until the words Ps Primary or Qc Primary depending on the desired sensor is displayed, above the calibration coefficients.
5. Select Zero [F1]. Do NOT press the Calibrate button.
6. Select the Mechanical Zero [F1] key.

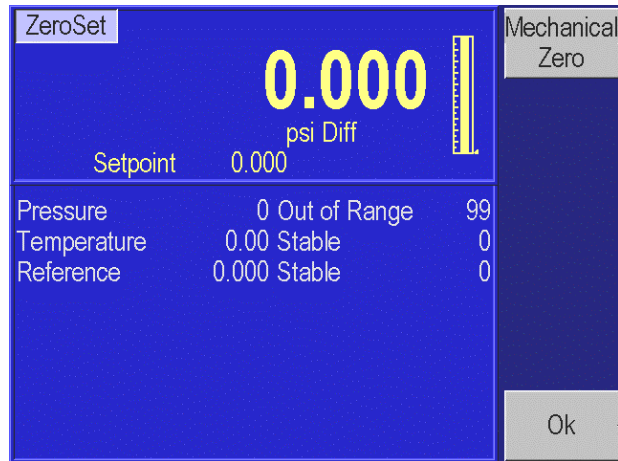

- Referring to Figure 6-5, slightly loosen the Allen screw on the back of the sensor bracket, making sure to maintain a snug fit on the screw. Using the T-shaped Photocell Centering Tool (RIC # 7750-111), adjust the photocells by placing the tool in the hole in the back of the sensor and turning the tool slightly. The screen will show a number of horizontal lines. The top yellow bar represents the current zero setting. The bottom portion of the bar has a green bar in the center and two red bars on either end. If the top yellow bar is over the red bar, then mechanical zeroing is required. If the yellow bar is over the green bar, then no adjustment is required.



- Adjusting the photocell will cause the yellow bar to reduce in width. You want to adjust the photocell until the yellow line is as thin as possible over the green bar.



- Tighten the Allen screw.
- Often, when the Allen screw is tightened, the zero will move. Review the width of the yellow line, again loosen the Allen screw, and now offset the yellow bar the same width that you observed it moving from tightening the Allen screw, and now offset it in the opposite direction by this same width.

11. Again, tighten the Allen screw. Now the width of the yellow line should be minimized.
12. Tap on the bracket with a screwdriver handle to relieve mechanical stress. Continue to tap on the bracket until the counts stop changing.
13. If the zero moved significantly as a result from tapping the bracket, repeat this procedure as necessary.
14. Reinstall plastic zeroing plug.
15. After the unit has become thermally stabilized, perform a normal instrument zeroing procedure. Refer to Section 6.4.5.

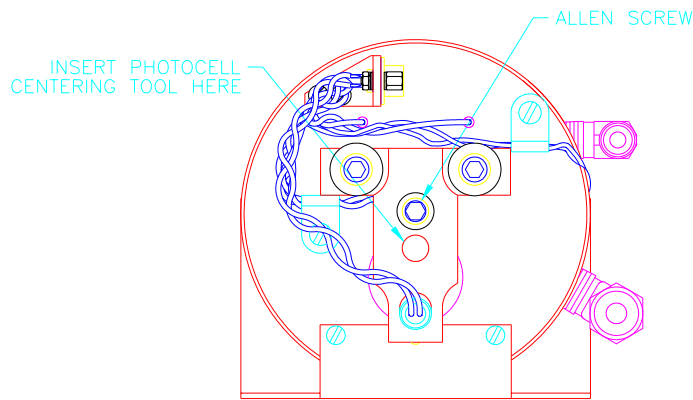

**FIGURE 6-5
PHOTOCELL LOCATION**

6.6 OPTIMIZING CONTROL

The performance of the controller may be optimized for certain environments or performance criteria by adjusting the values available in the Control screen. The Control screen is available from the Main Menu by pressing Menu [F6], Test [F5], Control [F6]. The Control screen is shown below.

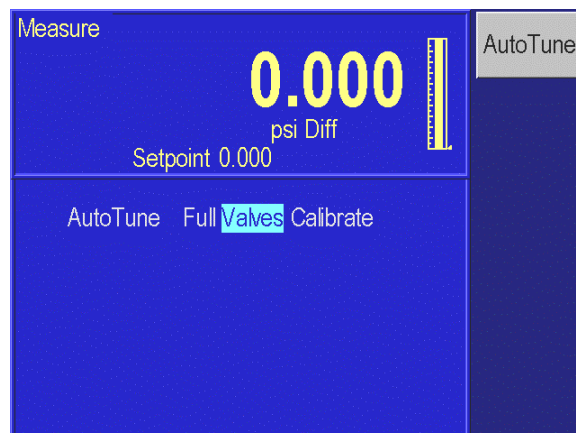

MENU | MENU | TEST | CONTROL

NOTE: Be sure the Control Band parameter is set to zero (Section 4.6.1.1.3).

If the controller does not control optimally, it would be recommended to first assure that the system is free of leaks and is operating within the external volume specifications (see Appendix A). You should verify that the instrument is fitted with the proper sized pressure lines to minimize flow restrictions (see Section 3.5). Verify that the control band is set as intended (see Section 4.6.1.1.3). For active control, when testing the controller the Control Band Off and Control Band On values should be set to zero. Finally verify that the control is set to Normal to minimum overshoot (see Section 4.6.1.1.4). If the system continues to control improperly, you can perform the Auto-tune. You will need to press the **[MODE]** key to select either the Ps or the Qc channel.

There are two options available to the operator.

Full – This fully characterizes the control function of the 7750i. It automatically adjust the control valve biases and aligns the inner loop high control pressure sensor to the high accuracy quartz sensor. This should be performed any time major components are replaced in the controller such as the control valves or the high-speed inner loop control sensor. Additionally, if the controller is not functioning properly, a full Auto-tune can be performed to optimize the control.

Calibrate – This automatically aligns the inner loop high control pressure sensor to the high accuracy quartz sensor. If in the Normal control mode (as opposed to the fast control mode), the controller overshoots the commanded pressure valve, this could be an indication that the inner loop control sensor needs to be realigned with the high accuracy quartz sensor. This is achieved by running the Calibrate Auto-Tune function.

NOTE: Prior to performing any Auto-Tune functions in an effort to improve the controller performance, confirm that the system is a leak free system and the volume attached to the test port is within the recommended range (see Appendix A). Additionally, assure that the system has adequate pressure and vacuum supply (when required).

To perform these Auto-Tune functions, the instrument must be connected to a pressure supply with the pressure supply set to the proper supply pressure (please refer to the specifications in Appendix A). On absolute instruments, a vacuum pump must be connected to the exhaust port.

Disconnect any device under test from the test port. The test port must be connected to a sealed volume of 5 to 15 cubic inches (80 to 240 cc's).

Use the Rotary knob to select which Auto-Tune procedure is to be performed and then press the enter key. The Full performs the complete Auto-Tune sequence. If selected, you are not required to run any of the other Auto-Tune functions. Press the enter key.

The ADTS will go through a sequence of controlling to various pressures and automatically adjusting the control parameters of the valves. The ADTS will display a message indicating

when it is complete with the Auto-Tune procedure. The time required to complete the Auto-tune procedure can range anywhere from 15 to 45 minutes.

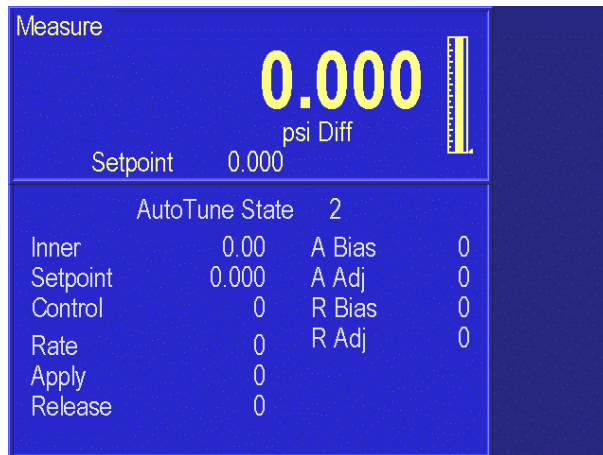

If any control valves or the high speed inner loop pressure sensor has been replaced, the Auto-Tune should be run to characterize the new hardware.

6.7 FAN OPERATION

The fan in the 7750i can be turned on or off. It is recommended to keep the fan ON since this will extend the life of the power supply.

When operating the system in either a very cold or hot environment, if the oven is unable to maintain the temperature of the internal oven, it will generate error Oven Control Failure Error messages. The operator can review the temperature and duty cycle of the oven by pressing the MENU | MENU | DISPLAY | **TEMPERATURE** keys. The unit must have been warmed up for a minimum of 2 hours prior to determining the condition of the oven temperature control. The temperature of the sensor should be controlled to 50° C. The Duty cycle indicates the percentage of time that the oven control is turned on in order to maintain the oven at the proper set-point of 50° C. A unit that is operating properly, after it has fully warmed up, should indicate a sensor temperature of 50° C and a duty cycle between 10 to 90%.

If operating the instrument in a very cold environment and the oven duty cycle is at a high percentage (>90%) you will need to turn the fan off. If you are operating in a warm environment or when multiple systems are housed in consoles without adequate ventilation, the system may become too hot and generate the oven control failure error message. If operating the instrument in a warm environment and the oven duty cycle is at a low percentage (>10%) you will need to turn the fan on.

When the operator changes the status of the fan, it will default to that condition until it is changed by the operator.



MENU | MENU | TEST| SHOP 1 – MENU

To turn the fan on or off, press Menu [F6] from the Main Menu, then Test [F5], then Shop1 [F5].

Use the rotary knob to highlight either fan Off or On. Press [ENTER] to select.

6.8 SYSTEM SOFTWARE UPDATE PROCEDURE

NOTE: Calibration and other stored constants are not affected by program updates.

The update procedure requires a PC connected to the RS-232 port on the 7XXX. (9-pin to 9-pin, null modem cable minimum pinout 2-3, 3-2, 5-5).

1. When appropriate, Ruska can e-mail the latest version of the software for upgrading instruments. The e-mail will have a zip file attached contains two files UPDATE7.EXE and <version>.IMG. Unzip these files into a directory on the PC.
2. Set the 7XXX to 9600 baud, 8 databits, no parity, 1 stopbit.
3. Run the program Update7.
4. Follow the prompts to select the communications port and the image file.
5. When the upgrade is finished, Update7 running on the PC and the 7XXX should both display Complete.

6.8.1 Model 7750i Controller Software Upgrade

In addition to the main code, the 7750i include code for the pressure controller. The controller software version can be viewed by pressing the MENU/TEST/REMOTE/SERIAL2 keys. The controller software version is displayed next to 'Ctrl'. This code can be upgraded through the RS-232 port on most units. Press the MENU/TEST/CONTROL key and check for 'Download Yes'.

(The digit in front of the R increases with revision levels and the last two digits will increment upwards as the revision level increases, e.g. 0R99 is older code than 1R01 which is older than 1R08, etc.)

1. Connect a PC to the RS-232 port on the 7XXX using a null modem cable.
2. The zip file labeled 7750 Control|XRX contains files UPDATE7.EXE and <version>.IMG. Unzip these files into a directory.

3. Set the 7XXX to 9600 baud, 8 databits, no parity, 1 stopbit.
4. Run the program Update7.
5. Follow the prompts to select the communications port and the image file.
6. Update 7 should display Complete.

Note, when updating the controller code, the 7750 will display various error messages. This is expected. The front display will freeze on the 7750 when the controller code is being downloaded. It will operate properly once the download is complete. Finally, the main software only reads the software versions on power-up. So, following the controller code upgrade, pressing the MENU/TEST/REMOTE/SERIAL2 keys will only show the new revision level of the controller code after power is cycled on the 7750.

6.9 REPLACEMENT PARTS

The following is a list of the common replacement parts used in the Model 7750 ADTS.

Valve Identification	Low Pressure Manifold Maximum Full Scale Pressure Range < 1000 psi (6895 kPa)		High Pressure Manifold Maximum Full Scale Pressure Range 1000 – 2500 psi (6.9 – 20.7 MPa)	
	Valve Body	Valve Coil	Valve Body	Valve Coil
Supply Pressure	88-1074	88-1081	88-1054	88-1055
Vent	88-1074	88-1081	88-1054	88-1055
Test Port	88-1076	88-1078	-	-
Reference Port	88-1076	88-1078	7750-109	88-1055

Part Number	Description
7250-109	7750xi isolation manifold valve body
88-1055	7750xi isolation manifold valve coil
11-763	TFT Display
11-764	Display Inverter Electronic Board
7000-70	Sensor LED Lamp Assembly
7000-71	Sensor Photocell
62-293	Power Supply
23-906	Fan
7250-100-005	Rotary Encoder

SECTION 7.0 PREPARATION FOR STORAGE & SHIPMENT

NOTE: The procedures given in sections 7.1 through 7.3 must be strictly adhered to in order to prevent damage to the instrument. Failure to follow these procedures will likely result in damage to the ADTS during shipment. This damage is not covered by the carrier's insurance.

7.1 DISCONNECTING THE ADTS

1. Relieve all pneumatic pressure from the ADTS.
2. Turn the ADTS power switch to the off position.
3. Disconnect the power cable from the ADTS power receptacle.
4. Disconnect all pneumatic lines from the ADTS's back panel.
5. Plug all ports.

7.2 PACKING INSTRUCTIONS

To prevent shipping and handling damage to the instrument, adhere to and strictly follow the instructions below.

The governing discipline in ensuring a damage-free shipment is to ensure that the possibility of handling shocks to the ADTS is minimized and/or prevented during transit. Ruska accomplishes this task by cradling the ADTS within two foam cradles that are encapsulated within a double-walled, corrugated box. The ADTS is restrained and supported, but still has resilience. The materials used in the packaging operation are foams that have a minimum impact rating of not less than N-95.

Styrofoam, poured "foam in place" mixtures, and other rigid foams are not recommended.

If polyfoam or rubber foam other than that used in the original packaging is to be used, cut it into strips so that it will not present a large rigid surface to the ADTS.

Ruska has found that corrugated cardboard boxes provide the best packaging exterior. The box must have an impact rating of 275 lb and be of double-walled construction. This type of box will sustain most types of damages incurred during the shipping and handling process, but ensures that the contents remain intact and damage-free. The foam cradle ensures that a minimum of 3 inches of foam separates the inner surface of the box and any portion of the ADTS. *Wood or metal boxes do not absorb shock when dropped and therefore are not recommended.*

If the original packaging and shipping materials have been retained, use them for packing the ADTS. If the ADTS is being packed for long-term storage (more than 30 days), place a desiccant bag inside the box.

The ADTS must be prepared for shipment in the following manner:

1. GE Infrastructure Sensing has an RMA procedure in place. Please contact the Customer Service Center to obtain an RMA number prior to returning any equipment to Ruska. Have the following information available when contacting GE:
 - a. the part number,
 - b. the serial number,
 - c. the purchase order number,
 - d. the billing and ship to address, and
 - e. the buyer's name and telephone number.

This information plus the RMA number must be attached to the unit when it is shipped to GE Infrastructure Sensing. There will be a minimal charge for inspection and/or evaluation of returned goods.

2. Enclose the ADTS in plastic or any good water barrier material. Antistatic material is recommended.
3. If the original shipping carton is not usable or available, use a double-walled corrugated carton with a 275-lb rating. The recommended carton size is 25 1/2 x 19 1/2 x 12 3/8 inches.
4. Insert one foam cradle from the original shipment onto the floor of the box. (The original foam cradles are of the same type of construction and are completely interchangeable.) If the foam cradles are not available, cover the bottom and sides with no less than 3 inches of N-95 foam strips. Arrange the strips in the configuration illustrated in figure 7-1.
5. Before sealing the carton, include the following:
 - a. Statement of the problem or service needed. Be specific. Include the name and telephone number of a knowledgeable technician for consultation.
 - b. The part number, serial number, return address, and purchase order number.
6. Seal the carton using gummed tape.
7. Address the carton to:

GE INFRASTRUCTURE SENSING
10311 WESTPARK DRIVE
HOUSTON, TX 77042
USA

8. Label the carton with the following labels: THIS SIDE UP, HANDLE WITH CARE, DO NOT DROP, and FRAGILE. (If the original Ruska shipping carton is utilized for this shipment, the above markings are preprinted on the carton.)

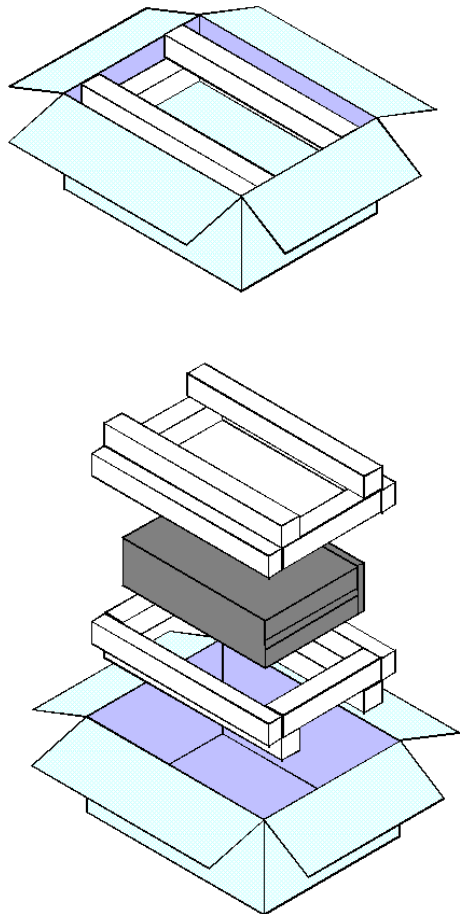

**FIGURE 7-1
PACKING THE ADTS**

7.3 SHIPPING INSTRUCTIONS

Ruska recommends using air freight for transportation. Surface transportation subjects the shipment to more frequent handling and much more intense shock. In most cases, if surface transportation is the mode of transport employed, handling damage is likely.

Again, it is essential that the procedures mentioned in sections 7.1 through 7.3 be strictly adhered to in order to prevent any shipping and handling damage to the instrument.

NOTES

APPENDIX A SUMMARY OF SPECIFICATIONS

A. UNCERTAINTY ANALYSIS

To perform an Uncertainty Analysis on a measurement device, you must be able to identify all of the parameters that influence the measurement. You must be able to quantify the magnitude of the potential error source and combine these into an overall uncertainty statement.

To determine the expanded uncertainty on any manufacturers pressure Transfer Standard (TS), you must identify the following four primary influences;

- 1.) Performance specifications of the TS
- 2.) Long term Stability of TS
- 3.) Uncertainty of the standard used to calibrate the TS
- 4.) Environmental or installation influences that could cause errors in the TS

A.1. Performance Specifications are the short-term measurement properties of the device. These traditionally include linearity, hysteresis, and repeatability properties of the transfer standard. There often is considerable confusion with the performance specification because different manufacturers use different terms to describe the performance characteristics of their instruments. The two most common terms used are "Accuracy" and "Precision". In both cases, as a minimum the manufacturers define these terms to be the combined effects of linearity, hysteresis and repeatability. Since the manufacturer defined the terms they used, this should not be a problem. However, it is common that the users definition of these terms differ from the manufacturers and therefore cause considerable confusion. For instance, the user may believe that the term "Accuracy" includes all sources of uncertainty. This would include items 1 through 4 listed above which would be an all encompassing specification. The manufacturer may define "Accuracy" as the performance specification which consist only of item 1 above. The result would be that the instrument would not be capable of meeting the users application because it would not meet the users definition of "Accuracy".

A.2 Long Term Stability defines how the instrument drifts with time. This specification can be utilized to define the calibration interval for the standard. Some manufacturers will provide more than one stability specification for their instrument based on different calibration time intervals. It is important to understand that you should not arbitrarily vary the manufacturers stability specification based on time without knowing the characteristics of their device. Some manufacturers identify that their stability specification is proportional with time. Therefore, if the calibration interval were reduced in half, the magnitude of the stability specification would also be halved. This can be a powerful tool when you are trying to improve the measurement performance of a standard. By reducing the calibration interval, the expanded uncertainty would also reduce. On the other hand, some manufacturers do not claim that their stability specification is proportional with time. This would be the case for instance if the instrument naturally drifted in a sinusoidal fashion. This would suggest that the sensor could drift to its maximum stability limit at any time and

therefore, reducing the calibration interval would not improve the expanded uncertainty of the device.

A.3 Short Term Stability relates to the zero drift characteristics of the instrument. This generally is classified as short term drift since the instrument can be re-zeroed without performing a full calibration as required to correct for long term span drifts. The magnitude of zero drift can be assessed based on the length of time between re-zeroing the instrument.

A.4 Uncertainty of the Standard used to calibrate the transfer standard. This is the expanded uncertainty of the calibration standard that was used by the manufacturer to calibrate the digital transfer standard. This should be the expanded uncertainty of the calibration standard and include all sources of uncertainty that would influence the calibration standard including the uncertainty from the National Standards Laboratory that the standard is traceable.

It should also be noted that when the instrument is re-calibrated, the uncertainty of the device is influenced by the uncertainty of the calibration standard that will be used to perform the re-calibration. Therefore, the uncertainty analysis should be evaluated following each re-calibration. If the instrument is re-calibrated using a different calibration service provider than the manufacturer, the uncertainty of the standard that the calibration service provider used to perform the calibration would need to be substituted for the manufacturers calibration uncertainty that was used in the original uncertainty analysis.

A.5 Environmental or Installation Influences that could cause errors in the transfer standard. This includes influences such as ambient temperature, line pressure, head pressure, time response, and controller effects. (It may include other influences that are very specific to one manufacturers instrument.) It is recommended that the intended application is reviewed to assure that the environmental does not impact the instruments performance, or that the impact from the environment is accounted for in the uncertainty analysis. For instance, if an instrument has a 0.001%FS per degree Celsius temperature effect from a calibrated temperature of 20 degrees Celsius, and the instrument is to be used in an environment where the temperature will vary from 15 to 25 degree Celsius, then a +/- 0.005% of full scale uncertainty should be included in the uncertainty analysis for ambient temperature effects.

A.6 Absolute Zeroing Reference Sensor - The two sigma expanded uncertainty of the vacuum sensor used to zero the absolute Ps sensor is estimated to be less than or equal to 10 mtorr (1.33 Pa) per year.

A.7 Combining the Uncertainty Components into an Expanded Uncertainty Statement

Once all of the uncertainty components are identified, they can be combined into an overall Expanded Uncertainty Statement for the instrument. The vast majority of the measurement community has adopted a statistical approach to uncertainty analysis such as the International Organization for Standards (ISO) Guide to the Expression of Uncertainty in Measurement. This statistical approach combines all of the uncertainty components in quadrature (RSS).

In this approach, it is important to define the level of confidence that all of the uncertainty components are defined. For instance, all of the uncertainty specifications that GE Infrastructure Sensing Houston publishes are at the 2 sigma level which would be at a 95%

confidence level. Some manufacturers may state their uncertainty at different confidence level and therefore, you would need to be able to convert from one to the other in order to compare the two devices. For instance, if a manufacturer states that they have an uncertainty of 0.005% FS and that the uncertainty is expressed at the 1 sigma level, then it would be doubled to express it at the 2 sigma level (i.e. it would be an 0.01% FS device at a 2 sigma or 95% confidence level.)

A.8 Controller Specification

When the system is in control mode, the control noise is defined as how close the controller can maintain the control pressure to the commanded set-point. In the active control mode, the 7250 has a control noise specification of 0.001% of Full Scale.

In the Passive control mode, since the controller shuts off when it reaches a user-defined band about the commanded set-point, the uncertainty of the pressure measurement is not influenced by the controller.

The following tables are uncertainty analysis examples for a 7750i based on a three month and a yearly calibration.

Uncertainty Analysis – Model 7750i	90 Day Uncertainty 32 inHg Ps Sensor (2 sigma)	1 year Uncertainty 32 inHg Ps Sensor (2 sigma)
A.1 Performance – (Linearity, Hysteresis, Repeatability and Temperature)	Greater of 0.005% of Rdg or 0.0004 inHg	Greater of 0.005% of Rdg or 0.0004 inHg
A.2 Span Stability – (3 months)	0.0019% of Rdg/90 days	0.0075% of Rdg/year
A.3 Zero Stability – (re-zero at 8 hours)	0.0004 inHg	0.0004 inHg
A.4 Calibration Standard – (Abs. Mode) (Ruska Model 2465 or 2468 DWG)	0.001% Rdg & 0.00039 inHg	0.001% Rdg & 0.00039 inHg
A.5 Environmental –		
Temperature (Included in A.1)	0.000% of Rdg	0.000% of Rdg
Head Pressure (+/-0.25 in)	0.0007% of Rdg	0.0007% of Rdg
Control – (in Passive Control)	0.000% of Rdg	0.000% of Rdg
A.6 Vacuum Reference Zeroing Sensor	0.00039 inHg	0.00039 inHg
A.7 Two Sigma Expanded Uncertainty	RSS(0.0055% Rdg & 0.0008 inHg)	RSS(0.0091% Rdg & 0.0008 inHg)

Uncertainty Analysis – Model 7750i	90 Day Uncertainty 40 inHg Ps Sensor (2 sigma)	1 year Uncertainty 40 inHg Ps Sensor (2 sigma)
A.1 Performance – (Linearity, Hysteresis, Repeatability and Temperature)	Greater of 0.005% of Rdg or 0.0005 inHg	Greater of 0.005% of Rdg or 0.0005 inHg
A.2 Span Stability – (3 months)	0.0019% of Rdg/90 days	0.0075% of Rdg/year
A.3 Zero Stability – (re-zero at 8 hours)	0.0005 inHg	0.0005 inHg
A.4 Calibration Standard – (Abs. Mode) (Ruska Model 2465 or 2468 DWG)	0.001% Rdg & 0.00039 inHg	0.001% Rdg & 0.00039 inHg
A.5 Environmental –		
Temperature (Included in A.1)	0.000% of Rdg	0.000% of Rdg
Head Pressure (+/-0.25 in)	0.0007% of Rdg	0.0007% of Rdg
Control – (in Passive Control)	0.000% of Rdg	0.000% of Rdg
A.6 Vacuum Reference Zeroing Sensor	0.00039 inHg	0.00039 inHg
A.7 Two Sigma Expanded Uncertainty	RSS(0.0055% Rdg & 0.0009 inHg)	RSS(0.0091% Rdg & 0.0009 inHg)

Uncertainty Analysis – Model 7750i	90 Day Uncertainty 32 inHg Qc Sensor (2 sigma)	1 year Uncertainty 32 inHg Qc Sensor (2 sigma)
A.1 Performance – (Linearity, Hysteresis, Repeatability and Temperature)	Greater of 0.005% of Rdg or 0.0004 inHg	Greater of 0.005% of Rdg or 0.0004 inHg
A.2 Span Stability – (3 months)	0.0019% of Rdg/90 days	0.0075% of Rdg/year
A.3 Zero Stability – (re-zero at 8 hours)	0.0004 inHg	0.0004 inHg
A.4 Calibration Standard – (Ruska Model 2465 or 2468 DWG)	Greater of 0.0010% Rdg or 0.00002 inHg	Greater of 0.0010% Rdg or 0.00002 inHg
A.5 Environmental –		
Temperature (Included in A.1)	0.000% of Rdg	0.000% of Rdg
Head Pressure (+/-0.25 in)	0.0007% of Rdg	0.0007% of Rdg
Control – (in Passive Control)	0.000% of Rdg	0.000% of Rdg
A.6 Vacuum Reference Zeroing Sensor	0.000 inHg	0.000 inHg
A.7 Two Sigma Expanded Uncertainty	RSS(0.0055% Rdg & 0.0007 inHg)	RSS(0.0091% Rdg & 0.0007 inHg)

Uncertainty Analysis – Model 7750i	90 Day Uncertainty 68 inHg Qc Sensor (2 sigma)	1 year Uncertainty 68 inHg Qc Sensor (2 sigma)
A.1 Performance – (Linearity, Hysteresis, Repeatability and Temperature)	Greater of 0.005% of Rdg or 0.00085 inHg	Greater of 0.005% of Rdg or 0.00085 inHg
A.2 Span Stability – (3 months)	0.0019% of Rdg/90 days	0.0075% of Rdg/year
A.3 Zero Stability – (re-zero at 8 hours)	0.0009 inHg	0.0009 inHg
A.4 Calibration Standard – (Ruska Model 2465 or 2468 DWG)	Greater of 0.0010% Rdg or 0.00002 inHg	Greater of 0.0010% Rdg or 0.00002 inHg
A.5 Environmental –		
Temperature (Included in A.1)	0.000% of Rdg	0.000% of Rdg
Head Pressure (+/-0.25 in)	0.0007% of Rdg	0.0007% of Rdg
Control – (in Passive Control)	0.000% of Rdg	0.000% of Rdg
A.6 Vacuum Reference Zeroing Sensor	0.000 inHg	0.000 inHg
A.7 Two Sigma Expanded Uncertainty	RSS(0.0055% Rdg & 0.0012 inHg)	RSS(0.0091% Rdg & 0.0012 inHg)

A.9 SPECIFICATIONS

GENERAL SPECIFICATIONS

Pressure Range:	Standard available ranges; Ps: 32 inHg Abs. (0 to 1085 mbar Abs.) or, 40 inHg Abs. (0 to 1355 mbar Abs.) Qc: 32 inHg Diff. (0 to 1085 mbar Diff.) or, 68 inHg Diff. (0 to 2300 mbar Diff.) or,
Custom Ranges:	Consult Factory
Display:	6.4 inch, TFT Active Matrix Color
Display Resolution:	User-selectable up to 1:1,000,000
Electrical Power:	90–260 VAC, 50–400 Hz, 150 W
Operating Temperature:	18–36°C
Storage Temperature:	–20–70°C
Humidity:	5–95% relative humidity, non-condensing
Nominal Control Volume:	5–60 in ³ (80–1000 cc's)
Dimensions:	7" H x 16.5" W x 19" D (17.8 cm x 41.9 cm x 48.3 cm)
Weight:	25 lb (11.5 kg)
Standard Pressure Units:	Engineering Units: inHg at 0°C and 60°F, kPa, bar, psi, inH ₂ O at 4°C, and 20 °C, kg/cm ² , mmHg at 0°C, cmHg at 0°C, and cmH ₂ O at 4°C & four user defined linear units of measure. Aeronautical Units: Feet, Meters, Knots, Km/hr, Mach
Pneumatic Ports:	1/4-inch NPT female, with AN4 adapter for Pt and AN6 adapter for PS ports.
Relief Valves:	Test Port: 120% of Maximum Scaled Quartz Sensor Range
Supply Pressure:	60 psi +/- 5 psi (4 bar +/- 0.5 bar)
Supply Vacuum:	Minimum 50 liters per minute with auto vent feature, Ultimate vacuum less than 1 mtorr.

GAS SPECIFICATIONS

Pressure Source Medium:	Clean Dry Air or Industrial Grade Nitrogen, 99.5% pure
Pressure Source Particle Size Contamination:	≤50 microns
Pressure Source Max. Moisture Content:	-50 °C dew point
Pressure Source Max. Hydrocarbon Content:	30 ppm

SPECIFICATIONS: 7750i

	Ps		
Mode	Absolute		
Precision ¹	From 25% to 100% of FS: 0.005% of Reading Below 25% FS: 0.005% of 25% FS		
Stability; Over 3 Months: Over 1 Year:	0.0019% RDG/ 3 months 0.0075% RDG/year		
Zeroing Vacuum Sensor	± 10 mTorr (1.33 Pa)		
Active Control Stability	0.001% FS		
Control Low Limit ²	0.3 inHg a (10 mbar a)		
Zero Drift ³	<0.004%FS / 24hrs		
Standard Load Volume	5 to 60 in ³ (80 – 1000cc's)		
Total Uncertainty ⁴ (Aeronautical Units)	<u>32 inHg a</u> Sea Level ±2 ft 30,000 ±2 ft 60,000 ±7 ft	<u>40 inHg a</u> Sea Level ±2 ft 30,000 ±3 ft 60,000 ±8 ft	<u>100 inHg a</u> Sea Level ±3 ft 30,000 ±4 ft 60,000 ±15 ft
Total Uncertainty ⁴ (Engineering Units)	<u>32 inHg a</u> 5 ±0.0008 inHg 15 ±0.0013 inHg 30 ±0.0025 inHg 32 ±0.0030 inHg	<u>40 inHg a</u> 5 ±0.0009 inHg 15 ±0.0014 inHg 30 ±0.0026 inHg 40 ±0.0037 inHg	<u>100 inHg a</u> 5 ±0.0016 inHg 15 ±0.0019 inHg 30 ±0.0028 inHg 50 ±0.0046 inHg 100 ±0.0092 inHg
Rate of Climb	0 to 50,000 ft/min.		
Rate of Climb Tolerance	1% of Commanded to 50,000 ft		3% of Commanded to 50,000 ft

¹ Precision is defined as the combined effect of linearity, repeatability, and hysteresis throughout the operating temperature range. Some manufacturers use the word "Accuracy" in place of "Precision", however the meaning is identical.

² Requires vacuum pump to control 0 psig, or the vent mode can be used to obtain 0 psig.

³ Zero drift typically improves with sensor age.

⁴ Total Uncertainty is defined as the two sigma combined uncertainty of linearity, hysteresis, repeatability, thermal effects one year drift stability and the uncertainty in the GE Ruska primary standard, which include the uncertainty from NIST.

	Qc	
Mode	Differential	
Precision ¹	From 25% to 100% of FS: 0.005% of Reading Below 25% FS: 0.005% of 25% FS	
Stability; Over 3 Months: Over 1 Year:	0.0019% RDG/ 3 months 0.0075% RDG/year	
Zeroing Vacuum Sensor	N/A	
Active Control Stability	0.001% FS	
Control Low Limit ²	0 inHg D (0 mbar D)	
Zero Drift ³	<0.004%FS / 24hrs	
Standard Load Volume	5 to 60 in ³ (80 – 1000cc's)	
Total Uncertainty ⁴ (Aeronautical Units)	<u>32 inHg D</u> 50 ±0.1 knots 100 ±0.05 knots 250 ±0.02 knots	<u>68 inHg D</u> 50 ±0.2 knots 250 ±0.04 knots 500 ±0.02 knots 1000 ±0.02 knots
Total Uncertainty ⁴ (Engineering Units)	<u>32 inHg D</u> 0.5 ±0.0005 inHg 16 ±0.0013 inHg 32 ±0.0026 inHg	<u>68 inHg D</u> 0.5 ±0.001 inHg 16 ±0.0016 inHg 32 ±0.0027 inHg 68 ±0.0055 inHg

¹ Precision is defined as the combined effect of linearity, repeatability, and hysteresis throughout the operating temperature range. Some manufacturers use the word "Accuracy" in place of "Precision", however the meaning is identical.

² Requires vacuum pump to control 0 psig, or the vent mode can be used to obtain 0 psig.

³ Zero drift typically improves with sensor age.

⁴ Total Uncertainty is defined as the two sigma combined uncertainty of linearity, hysteresis, repeatability, thermal effects one year drift stability and the uncertainty in the GE Ruska primary standard, which include the uncertainty from NIST.

APPENDIX B SUMMARY OF ERROR MESSAGES

Negative error numbers are from the Standard Commands for Programmable Instruments (Version 1991.0).

Value	Description and Corrective Action
0	No Error.
-103	Invalid Separator. Check punctuation in the SCPI command.
-104	Data Type. The type of parameter data is incorrect.
-109	Missing Parameter. No valid parameter was found for the SCPI command.
-110	Command Header. The command name is not valid.
-113	Command Unknown. The command specified does not exist.
-114	Header Suffix. The numeric suffix for the command name is out of range.
-201	Remote Required
-221	Settings Conflict. The command could not be executed due to the current state of the DPC. Some commands cannot be executed while a program, self-test, or calibration is in progress.
-222	Out of Range. The value is not within the valid range. For pressures check high and low limits.
-281	Cannot create program. Program memory is full.
-282	Illegal Program Name. The name specified is not valid or does not exist.
-284	Program Currently Running. The command cannot be executed while a program is running.
-285	Program Syntax Error. The syntax of the program definition is not correct.
-286	Program Runtime Error. An error occurred while running the program. Usually the setpoint is out of range.
-313	Calibration Data Lost. The calibration data has been lost and the unit must be recalibrated.
-315	Configuration Data Lost. The configuration data has been lost. Check all parameters to be sure they are correct.
-330	Self-Test Failed. Check the display for the test that failed.
-350	Queue Overflow. The error queue was full and messages were lost.
-400	Query Error. A read request was received when there was nothing to read.
500	Controller Malfunction. Internal control failure.
501	High Limit Exceeded. The pressure was greater than the high limit.
502	Low Limit Exceeded. The pressure was less than the low limit.
503	Slew limit Exceeded. The pressure changed faster than the slew limit allowed.
504	Negative Qc Limit exceeded.
505	ARINC Limits Exceeded
521	Pressure Overrange. The pressure reading is outside the range of the DPC.
531	Oven Temp Overrange. Either the transistor that drives the heater for the quartz Bourdon tube sensor (section 2) or the oven temperature sensor itself is

	malfunctioning. To observe the oven temperature, select OK then select MENU/DISP. Check the transistor and sensor for malfunction, requesting service (section 7) if necessary.
532	Vacuum Sensor Overrange
533	Case Pressure Overrange. Select OK, then reduce the pressure at the case reference port to 30 psia or lower.
538	Automatic Vent
540	Mechanical Zeroing Needed. The zero point of the quartz Bourdon sensor is beyond the range of the compensation circuit. The zero is adjusted by the software but should be manually adjusted for complete accuracy.
542	Oven Control Failure. The temperature controller is unable to keep the sensor at the proper temperature.
545	Sensor Communication Error. Unable to Communicate with 7215xi Sensor
546	Sensor Calibration Lost. The 7215xi sensor has lost its calibration and must be recalibrated.
600	Factory Data Lost. Internal factory constants have been lost. Contact Ruska for more information.
601	Calibration Mode. The Calibrate button must be pressed before SCPI calibration commands can be executed.
707	Pressure Too High
800	Solenoid Over-Temperature. The control solenoids have over-heated. Wait until they have cooled before entering Control mode.
801	Error reading Barometric RPT Pressure Sensor
802	Control Sensor out of range
803	Controller Communication Error
804	Autotune Failed

U.S.A.
10311 Westpark Drive
Houston, TX 77042
T 713 975 0547
F 713 975 6338



imagination at work

7750i-1D01, Revision A,
December 3, 2004